



- Installation Manual -

564 492 FM
Front Member Powerbrace



CUSCO USA Inc.
16631 Gemini Lane
Huntington Beach, CA 92647
Tel: (714) 907 - 0033
Fax: (714) 369 - 8142
info@cuscouainc.com
www.cuscouainc.com

Thank you for purchasing CUSCO products. Please make certain that this instruction manual and the vehicle's factory service manual is fully read and acknowledged prior to installation. When transferring usage of the product, please make sure the instruction manual is given to the new owner with the product, or to anyone operating the vehicle. When this product or the vehicle equipped with this product is given/let borrow to others, please hand this manual to the person who receive the product or vehicle.



Wear protective eyewear and gloves.



Please read this first

Attention

A potential possibility of malfunction and (or) breakage can result to the product and (or) to the vehicle if this indication is ignored, if wrongful usage and (or) operation is performed.

- This instruction manual includes the usage and installation. Read this manual thoroughly before operating. Please keep this instruction in the vehicle at all times.
- This product is for off-road or competition use only. By reading this warning the customer acknowledges that Cusco products are not permitted for use on public highways.
- This product includes all components listed in this instruction manual. If there are any missing or damaged parts, please contact an authorized CUSCO retailer.
- Always disconnect the battery before beginning any type of work on the vehicle.
- CUSCO cannot be responsible for any loss or damage to the product or the vehicle, when used in combination with other product(s) and (or) unauthorized tamperment to this product.
- CUSCO cannot be responsible for any injury or damage caused to the individual or third party as well as malfunction of the vehicle, products and (or) accessories.
- This product and accessories can be changed without prior notice due to production and manufacturing reasons.
- CUSCO cannot be responsible for any factory OEM parts lost during temporary removal process when performing installation.
- Some components such as car audio and clock can lose memory when the battery is disconnected while installing. After completion of the installation process, recover the setting referring to each instruction manual. CUSCO cannot be responsible for lost settings.
- Perform periodical inspection. The durability of this product can vary depending the surrounding conditions and usage.
- CUSCO cannot be responsible for any voided factory warranty due to installation of this product.
- Acknowledge that the installation of CUSCO products will alter vehicle control characteristics. Operate vehicle with extreme caution after product installation.
- Always install products according to the automobile manufacturer factory service manual unless otherwise specified in this installation manual.

Danger

An immediate possibility of serious injury and (or) even death can be assumed to the individual and (or) to the third party if this indication is ignored and wrongful usage and (or) operation is performed.

- Any service to the car with removal of the parts should be performed by trained professionals at a properly equipped workshop.
- Resting, sleeping in the car, or working in the car or in the closed garage can cause carbon monoxide poisoning, which can be fatal. Must turn the engine off and keep the area well ventilated.
- Always place wheel chock to prevent the vehicle from moving.
- Be careful with wiring when making connections directly in relationship with driving equipment, such as engine, steering, brake, and air-bag.
- Always make sure that the wiring is done properly. Take extra caution when dealing with positive and negative polarity. Make sure that the wires are insulated and there are no loose wires. If any wiring is performed in error, it may cause a fire on this product and/or the vehicle. Please disconnect the battery terminal wires before beginning the installation process. In case if it is not possible to shut off the power supply, it is your own responsibility to protect yourself from any injury as well as avoid electric shock and/or short circuit which can cause damage to the product and/or the vehicle.
- Use and install Cusco products only as directed by the manufacturer. Do not modify product to fit unspecified application. Misuse of product may lead to serious injury or death.

Warning

A potential possibility of serious injury and (or) even death can be assumed to the individual and (or) to the third party if this indication is ignored and wrongful usage and (or) operation is performed.

- Exhaust manifold, radiator, and engine can be very hot. Please provide sufficient cool down time before starting any installs.
- Exhaust manifold, radiator, engine can be extremely hot while the vehicle is running immediately prior to vehicle usage. There is high possibility of injury when coming in contact with such components.
- Keep clear from infants, small children, and animals. Keep small parts away to avoid accidents. (prevent the parts from being swallowed/inhaled)
- Exhaust pipe can be very hot. Wear proper protective clothing when working in or around this area.
- Avoid installing any product in areas that can interfere with vision of the front windshield, driving equipments, and/ or air-bag system and other safety features..
- Take caution when installing this product near electric wires, water hoses, and air hoses. and avoid inflicting and damages to them. Damaging the electric wires, water hoses, and air hoses can cause short circuit and/or critical engine damage.

Caution

A potential possibility of serious injury and (or) even death can be assumed to the individual and (or) to the third party if this indication is ignored and wrongful usage and (or) operation is performed.

- Dropping and/or applying the excessive force to this product before or during installation can cause damage, resulting in malfunction of the product.
- This product is designed to be used in 12V power vehicles only. Do not install this product in different voltage supplied vehicle.
- Make sure to insulate the unused connector and wirings to avoid short circuiting.
- Always use the supplied hardware.
- Installation of components on the passenger side or center section can interfere with safety standards. Please check within local regulations before installing.
- Use a soft cloth to clean the product gently. Using cleaners or abrasive agents can damage the product.

Notes

Warning

- Installation by non-professionals and unauthorized shops voids product warranty.
- Always focus on driving first, and never on the gauge displays. This may cause vehicle accidents and can even result in death.
- Perform product setting adjustment and other operation when the vehicle is parked at safe place.
- Do not disassemble or apply any modifications to this product. Such alterations can cause vehicle accidents or product damage. This also voids the product warranty.
- If any problem is found (wet/odor/smoke/erratic movement etc.), stop using the product IMMEDIATELY and contact your local retailer. Prolonged usage with such symptom can lead to accident or vehicle damage.
- CUSCO cannot be responsible for any damages while using this product, or any damages caused by this product usage.

[Part Number]	564 492 FM
[Application]	Mitsubishi Lancer Evolution VII Mitsubishi Lancer Evolution VIII Mitsubishi Lancer Evolution IX
[Product]	Front Member Powerbrace
[Description]	Powerbrace Radiator Support Beam
[Contents]	Powerbrace x1 Tie wrap (Ziptie) x2

1.) Remove front bumper according to the diagram below

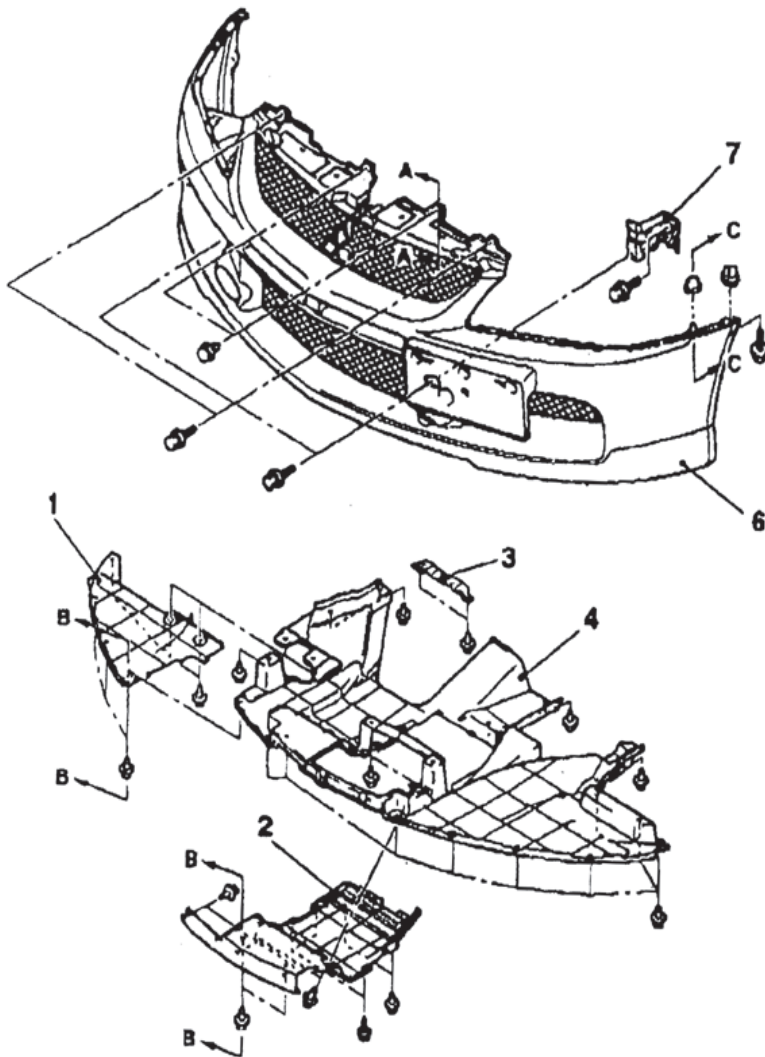

Order of Removal

- 1.) Side undercover
- 2.) Center undercover
- 3.) Undercover center bracket
- 4.) Front under cover
- 5.) Splash shield clips
- 6.) Front bumper assembly
- 7.) Front bumper brackets

Fastener A-A

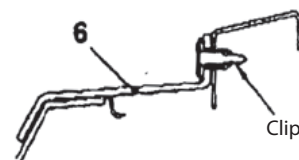

Fastener B-B

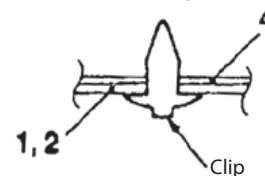

Fastener C-C

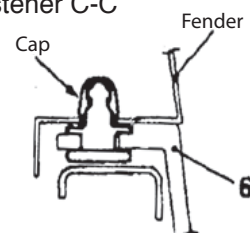

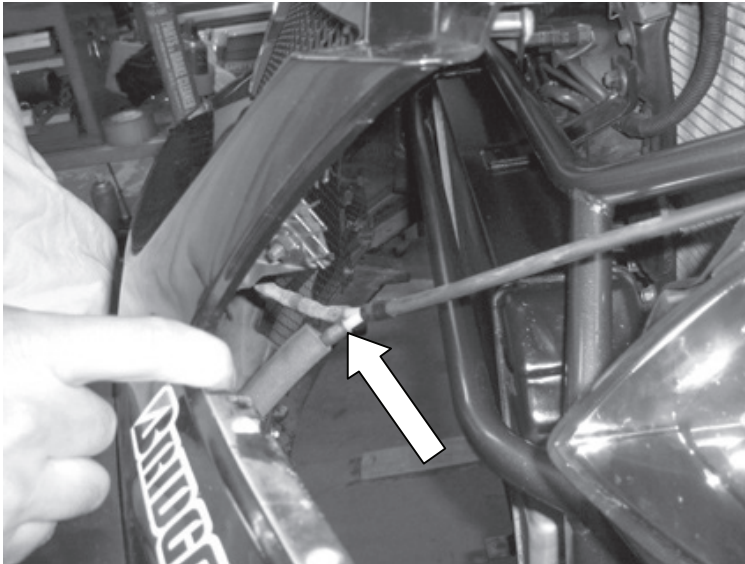

*Remove Intercooler Water Spray Hose (if applies)

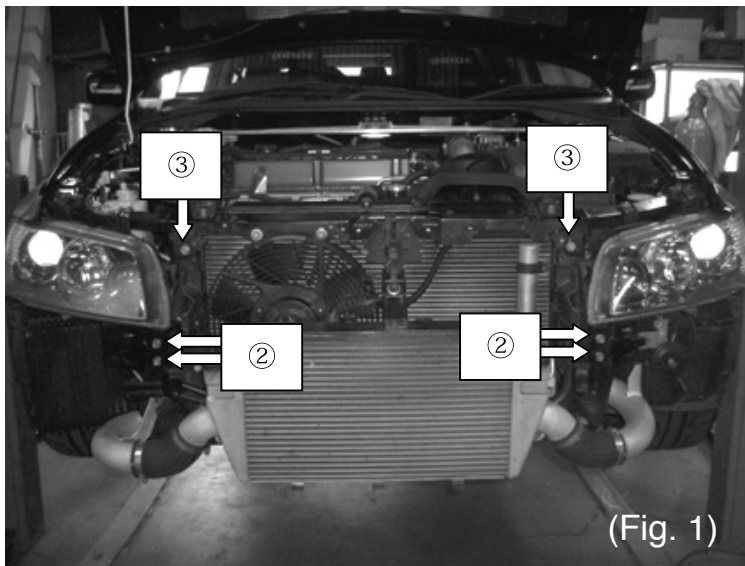

2.) Take off the bolts shown in Fig.1, to remove the bumper bracket. Save these bolts to mount the Powerbrace.

(The bumper bracket will no longer be used.)

3.) Take off the bolts shown in Fig.1. Save these bolts to mount the Powerbrace.

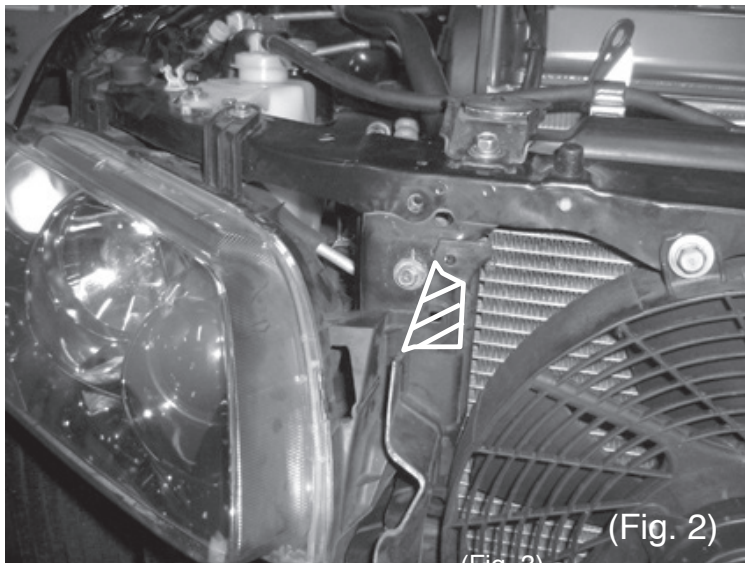

4.) The shaded area will make contact with the Powerbrace. Trim the shaded area shown in Fig.2. to give clearance. (Make sure to trim both driver & passenger side)

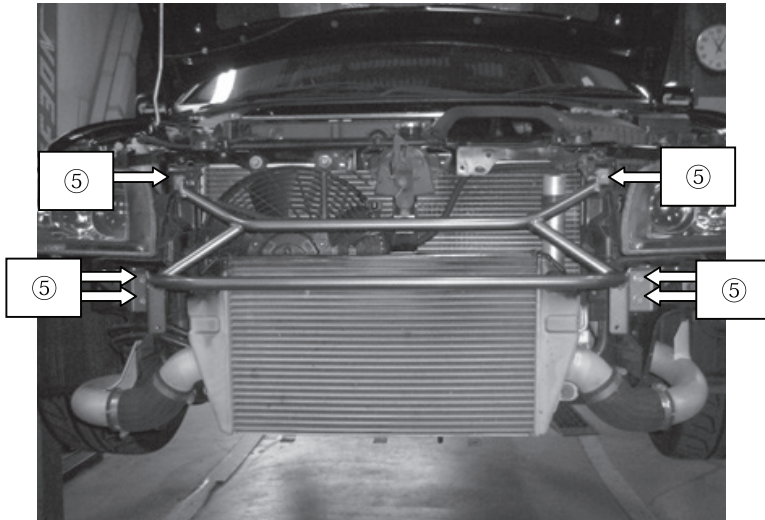

5.) Use the bolts removed from steps 2 and 3 to mount the Powerbrace shown in Fig.3
Please refer to the factory service manual for torque specifications.

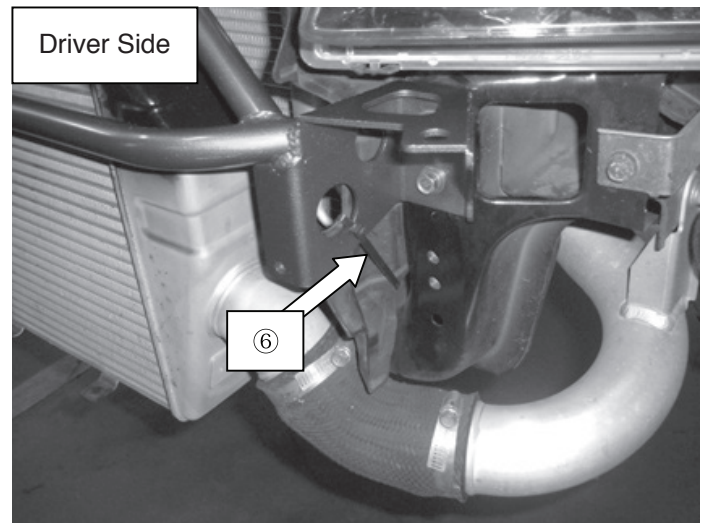
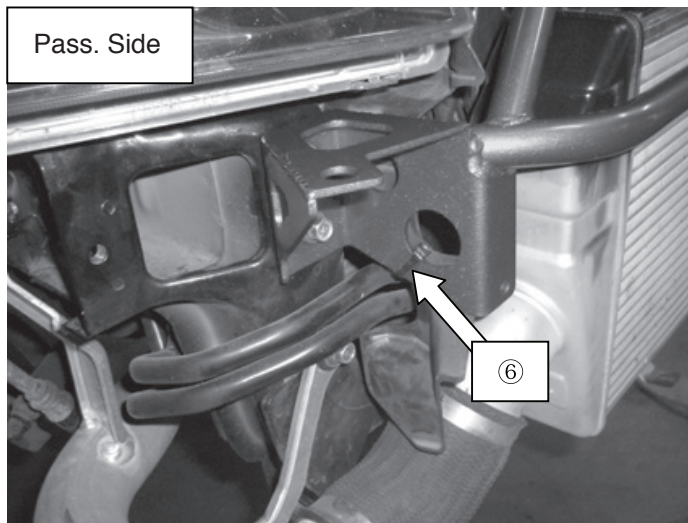

6.) Secure the cover to the Powerbrace using the included Tie wraps (Zipties).
7.) Install the bumper in the reverse order of removal.

*Periodically inspect and retorque all nuts and bolts after vehicle operation.