



- Installation Manual -

STRUT TOWER BAR



CUSCO USA Inc.
16631 Gemini Lane
Huntington Beach, CA 92647
Tel: (714) 907 - 0033
Fax: (714) 369 - 8142
info@cuscouainc.com
www.cuscouainc.com

Thank you for purchasing CUSCO products. Please make certain that this instruction manual and the vehicle's factory service manual is fully read and acknowledged prior to installation. When transferring usage of the product, please make sure the instruction manual is given to the new owner with the product, or to anyone operating the vehicle. When this product or the vehicle equipped with this product is given/let borrow to others, please hand this manual to the person who receive the product or vehicle.



Wear protective eyewear and gloves.



Please read this first

Attention

A potential possibility of malfunction and (or) breakage can result to the product and (or) to the vehicle if this indication is ignored, if wrongful usage and (or) operation is performed.

- This instruction manual includes the usage and installation. Read this manual thoroughly before operating. Please keep this instruction in the vehicle at all times.
- This product is for off-road or competition use only. By reading this warning the customer acknowledges that Cusco products are not permitted for use on public highways.
- This product includes all components listed in this instruction manual. If there are any missing or damaged parts, please contact an authorized CUSCO retailer.
- Always disconnect the battery before beginning any type of work on the vehicle.
- CUSCO cannot be responsible for any loss or damage to the product or the vehicle, when used in combination with other product(s) and (or) unauthorized tamperment to this product.
- CUSCO cannot be responsible for any injury or damage caused to the individual or third party as well as malfunction of the vehicle, products and (or) accessories.
- This product and accessories can be changed without prior notice due to production and manufacturing reasons.
- CUSCO cannot be responsible for any factory OEM parts lost during temporary removal process when performing installation.
- Some components such as car audio and clock can lose memory when the battery is disconnected while installing. After completion of the installation process, recover the setting referring to each instruction manual. CUSCO cannot be responsible for lost settings.
- Perform periodical inspection. The durability of this product can vary depending the surrounding conditions and usage.
- CUSCO cannot be responsible for any voided factory warranty due to installation of this product.
- Acknowledge that the installation of CUSCO products will alter vehicle control characteristics. Operate vehicle with extreme caution after product installation.
- Always install products according to the automobile manufacturer factory service manual unless otherwise specified in this installation manual.



Danger

An immediate possibility of serious injury and (or) even death can be assumed to the individual and (or) to the third party if this indication is ignored and wrongful usage and (or) operation is performed.

- Any service to the car with removal of the parts should be performed by trained professionals at a properly equipped workshop.
- Resting, sleeping in the car, or working in the car or in the closed garage can cause carbon monoxide poisoning, which can be fatal. Must turn the engine off and keep the area well ventilated.
- Always place wheel chock to prevent the vehicle from moving.
- Be careful with wiring when making connections directly in relationship with driving equipment, such as engine, steering, brake, and air-bag.
- Always make sure that the wiring is done properly. Take extra caution when dealing with positive and negative polarity. Make sure that the wires are insulated and there are no loose wires. If any wiring is performed in error, it may cause a fire on this product and/or the vehicle. Please disconnect the battery terminal wires before beginning the installation process. In case if it is not possible to shut off the power supply, it is your own responsibility to protect yourself from any injury as well as avoid electric shock and/or short circuit which can cause damage to the product and/or the vehicle.
- Use and install Cusco products only as directed by the manufacturer. Do not modify product to fit unspecified application. Misuse of product may lead to serious injury or death.



Warning

A potential possibility of serious injury and (or) even death can be assumed to the individual and (or) to the third party if this indication is ignored and wrongful usage and (or) operation is performed.

- Exhaust manifold, radiator, and engine can be very hot. Please provide sufficient cool down time before starting any installs.
- Exhaust manifold, radiator, engine can be extremely hot while the vehicle is running immediately prior to vehicle usage. There is high possibility of injury when coming in contact with such components.
- Keep clear from infants, small children, and animals. Keep small parts away to avoid accidents. (prevent the parts from being swallowed/inhaled)
- Exhaust pipe can be very hot. Wear proper protective clothing when working in or around this area.
- Avoid installing any product in areas that can interfere with vision of the front windshield, driving equipments, and/ or air-bag system and other safety features..
- Take caution when installing this product near electric wires, water hoses, and air hoses. and avoid inflicting and damages to them. Damaging the electric wires, water hoses, and air hoses can cause shot circuit and/or critical engine damage.



Caution

A potential possibility of serious injury and (or) even death can be assumed to the individual and (or) to the third party if this indication is ignored and wrongful usage and (or) operation is performed.

- Dropping and/or applying the excessive force to this product before or during installation can cause damage, resulting in malfunction of the product.
- This product is designed to be used in 12V power vehicles only. Do not install this product in different voltage supplied vehicle.
- Make sure to insulate the unused connector and wirings to avoid short circuiting.
- Always use the supplied hardware.
- Installation of components on the passenger side or center section can interfere with safety standards. Please check within local regulations before installing.
- Use a soft cloth to clean the product gently. Using cleaners or abrasive agents can damage the product.

Notes



Warning

- Installation by non-professionals and unauthorized shops voids product warranty.
- Always focus on driving first, and never on the gauge displays. This may cause vehicle accidents and can even result in death.
- Perform product setting adjustment and other operation when the vehicle is parked at safe place.
- Do not disassemble or apply any modifications to this product. Such alterations can cause vehicle accidents or product damage. This also voids the product warranty.
- If any problem is found (wet/odor/smoke/erratic movement etc.), stop using the product IMMEDIATELY and contact your local retailer. Prolonged usage with such symptom can lead to accident or vehicle damage.
- CUSCO cannot be responsible for any damages while using this product, or any damages caused by this product usage.

[Part Number]	949 540 A
[Application]	Toyota Vitz RS / Yaris [NCP131, NSP130] Toyota Ractis [NCP120, NSP120] Toyota Trezia [NSP120X] Toyota Aqua / Prius C [NHP10]
[Product]	Strut Tower Bar
[Description]	Front Type-OS Strut Tower Bar
[Contents]	Specialty Bolt x2 M8 Flanged Nut x4 Spiral Tube (Used for NHP10) x1

Installation procedure for NCP120/NSP120 Ractis & NSP120X Trezia

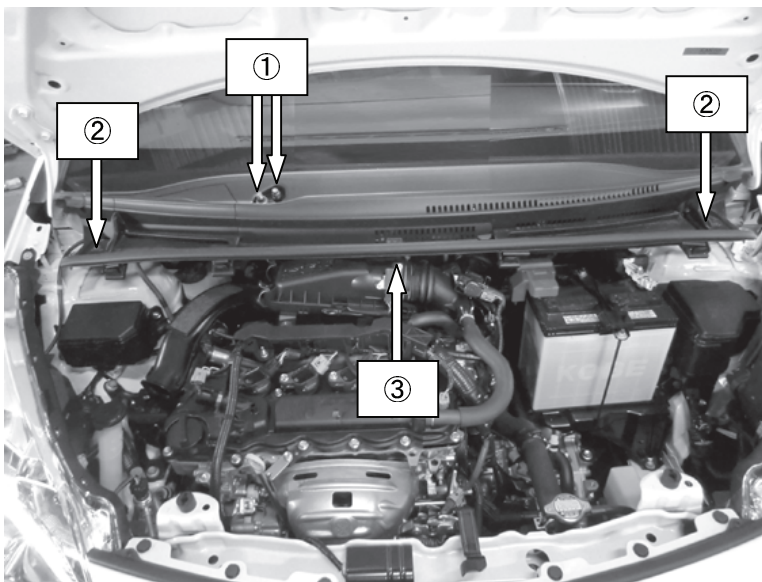

[Procedure]

- 1.) Remove the wiper arms.
- 2.) Remove plastic clips for the cowl.
- 3.) Carefully pull up and remove the entire plastic cowl top.

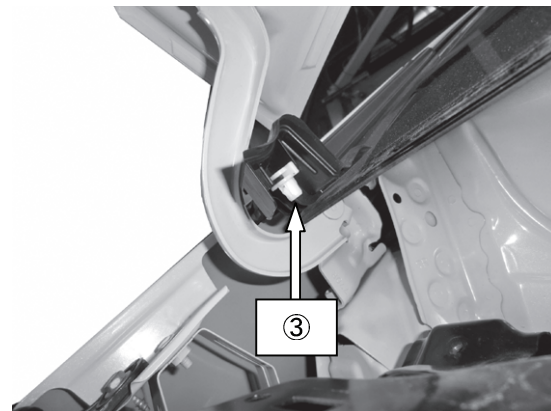
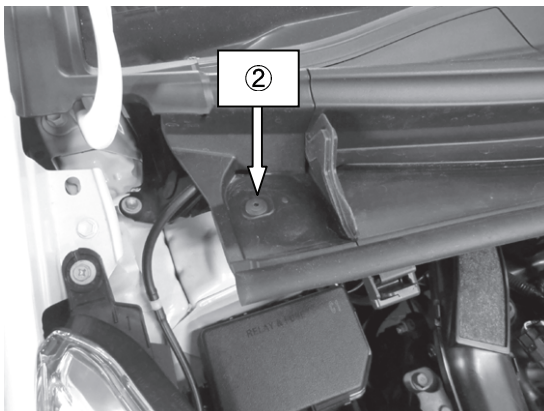

- 4.) Disconnect the wiper motor wiring connector and unclip from the cowl top panel.
- 5.) Take off the bolts to remove the entire wiper link assembly.

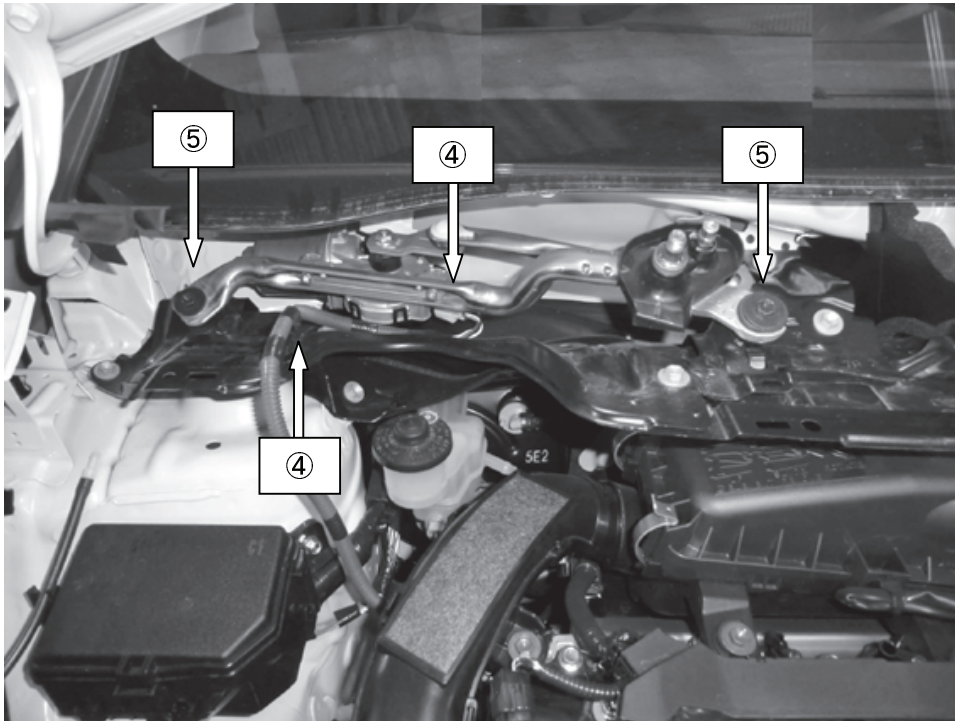

- 6.) Take off all the bolts indicated below to remove both left and right metal cowl top assembly.

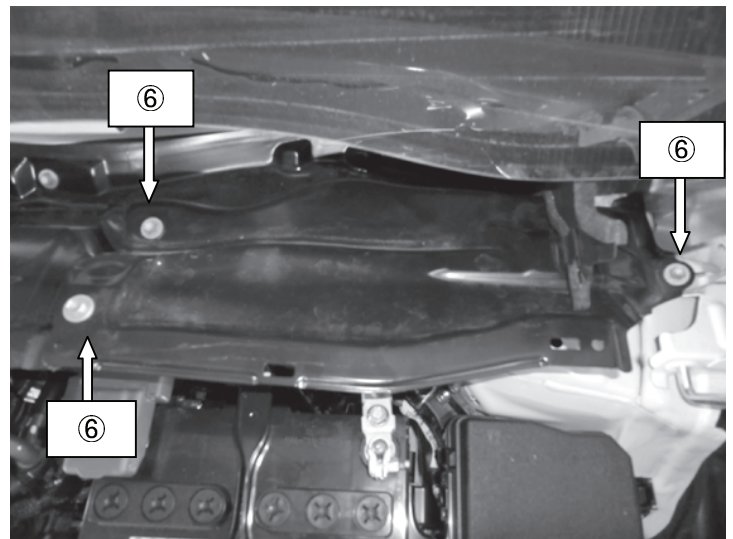
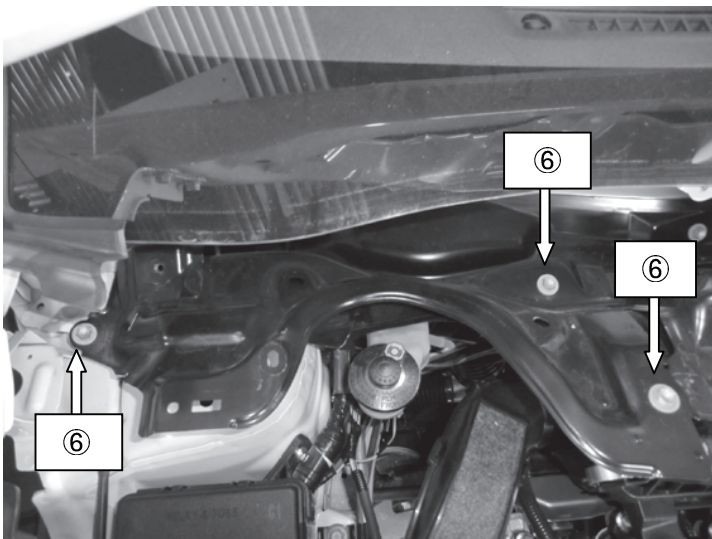

- 7.) Locate the two mounting holes on each strut tower area. Insert the included specialty bolt from under the fender wheel well while placing the strut tower bar on top. Torque down the strut tower bar using the included M8 Flanged Nuts.

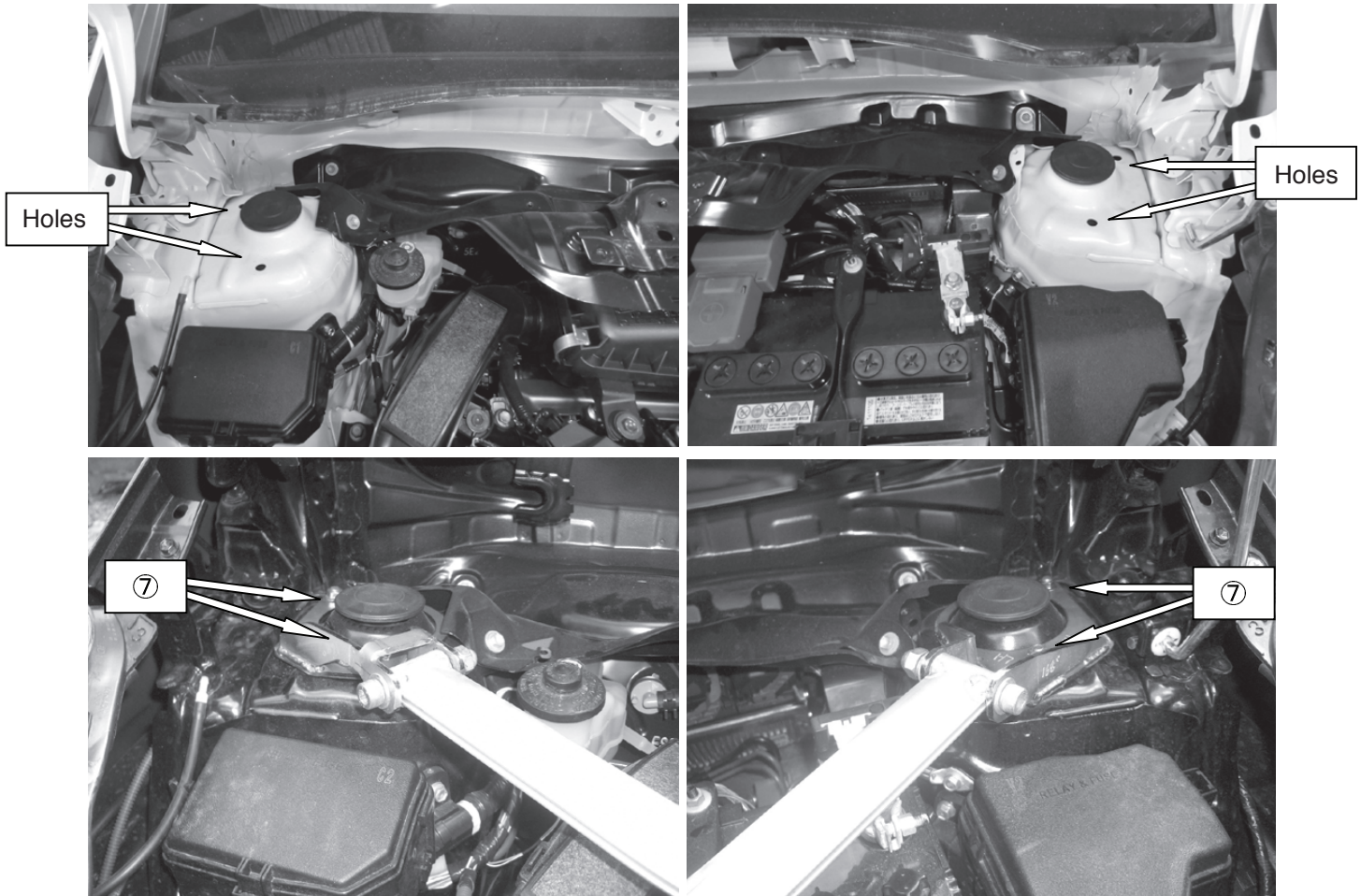

- 8.) Reinstall all components in reverse order it was taken off. Tighten all nuts and bolts according to manufacturer factory service manual torque specifications.

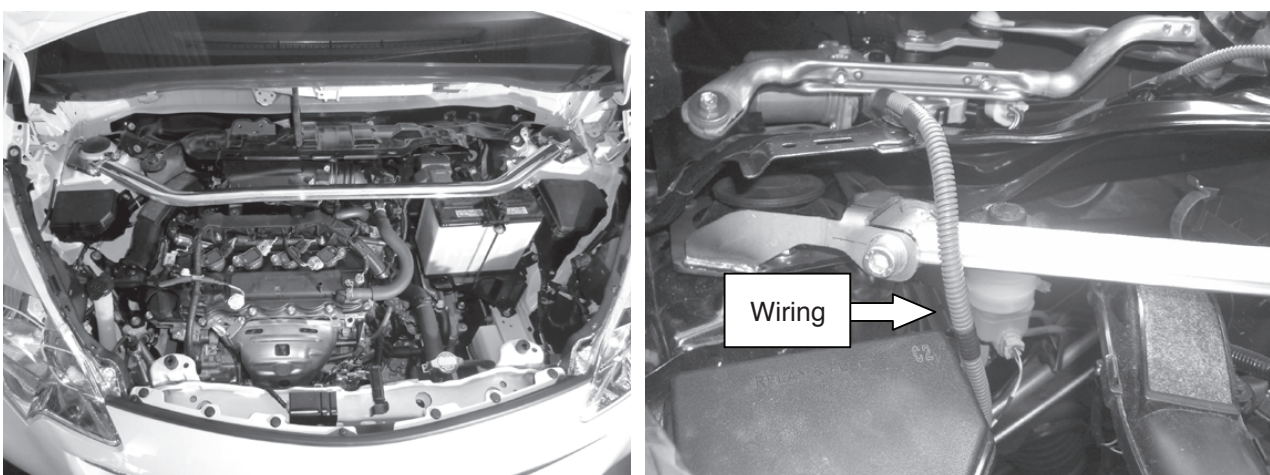

*Periodically inspect and retorque all nuts and bolts after vehicle operation.

Installation procedure for NCP131/NSP130 Vitz/Yaris

- 1.) Unplug the windshield wiper hose and remove it from its clamp.
- 2.) Remove the wiper arms.
- 3.) Remove the clips located on both left and right sides to take off the cowl top.

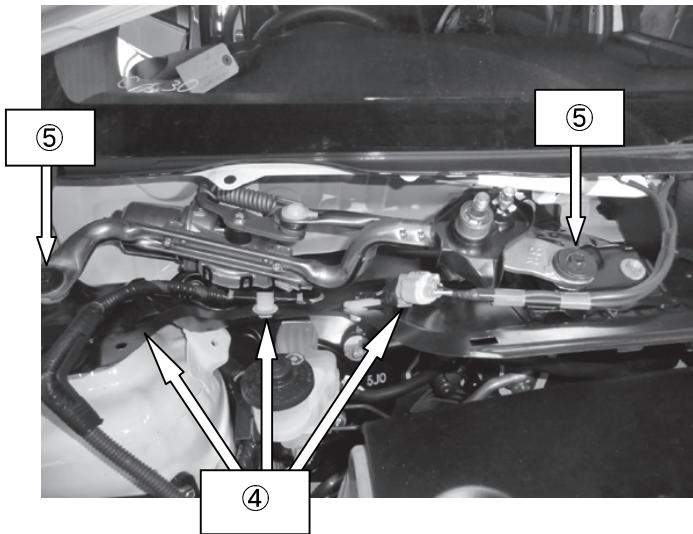
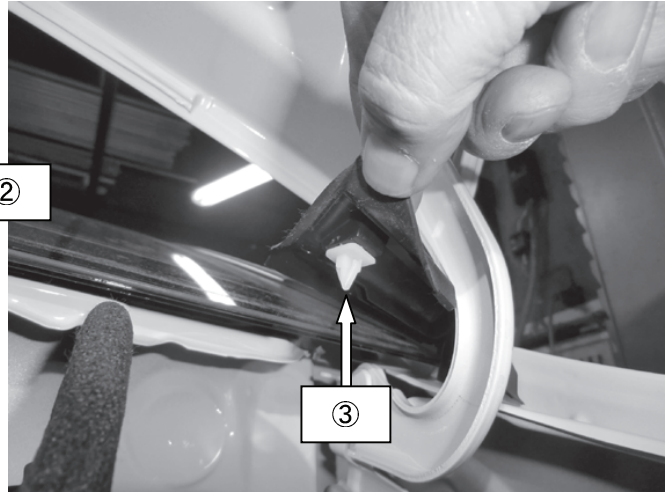
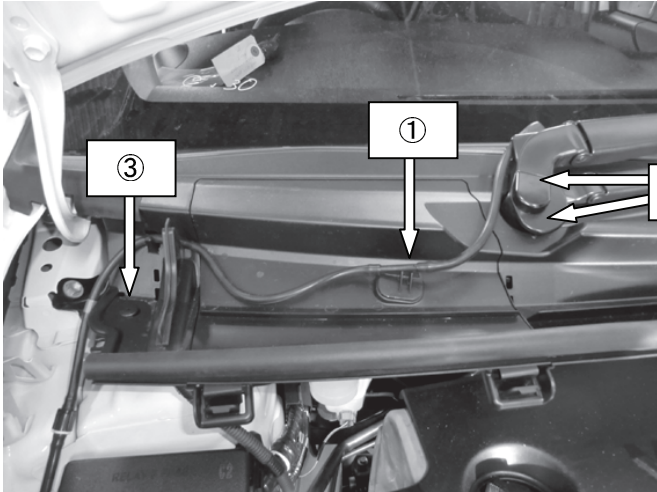

- 4.) Disconnect the wiper motor wiring connector and unclip from the cowl top panel.

- 5.) Take off the bolts to remove the entire wiper link assembly.

- 6.) Take off all the bolts indicated below to remove the metal cowl top assembly.

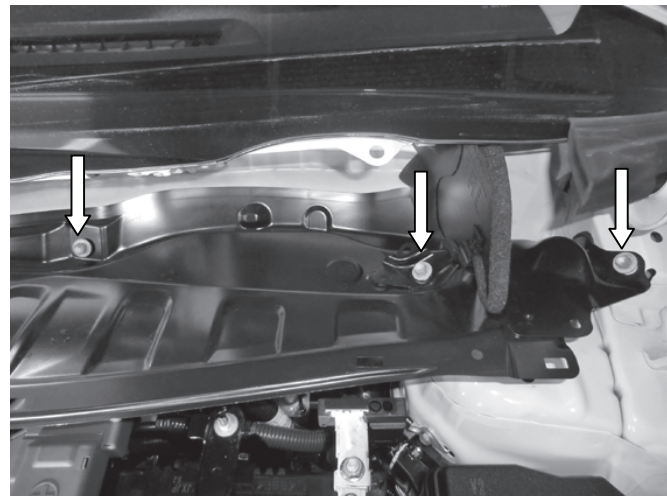
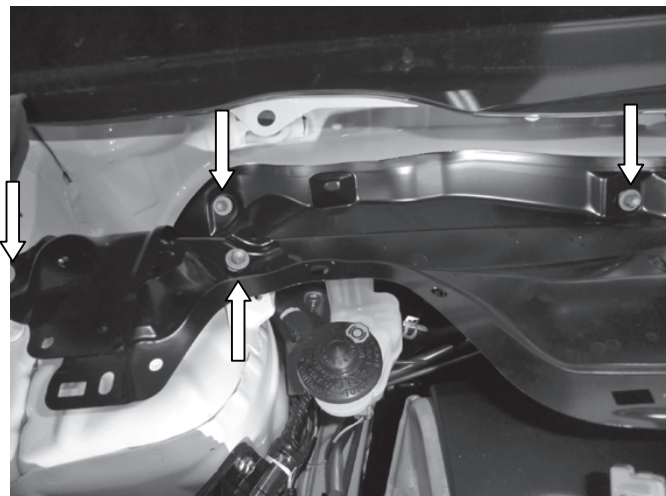

- 7.) Locate the two mounting holes on each strut tower area. Insert the included specialty bolt from under the fender wheel well while placing the strut tower bar on top. Torque down the strut tower bar using the included M8 Flanged Nuts.

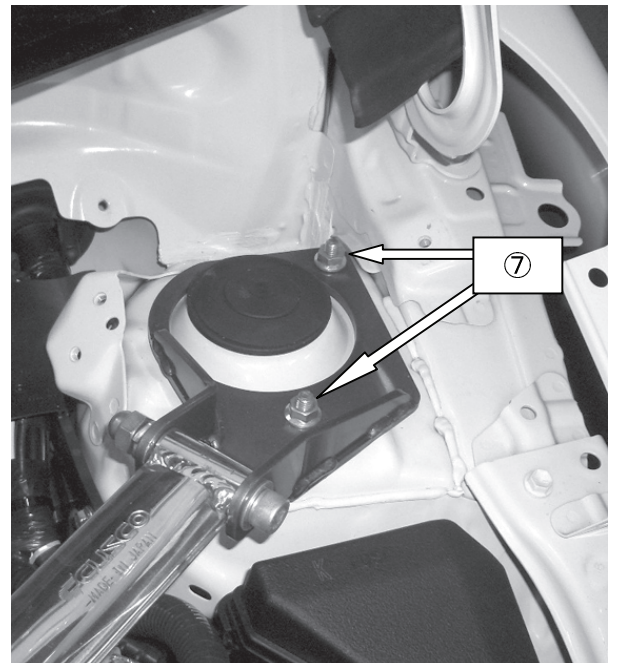
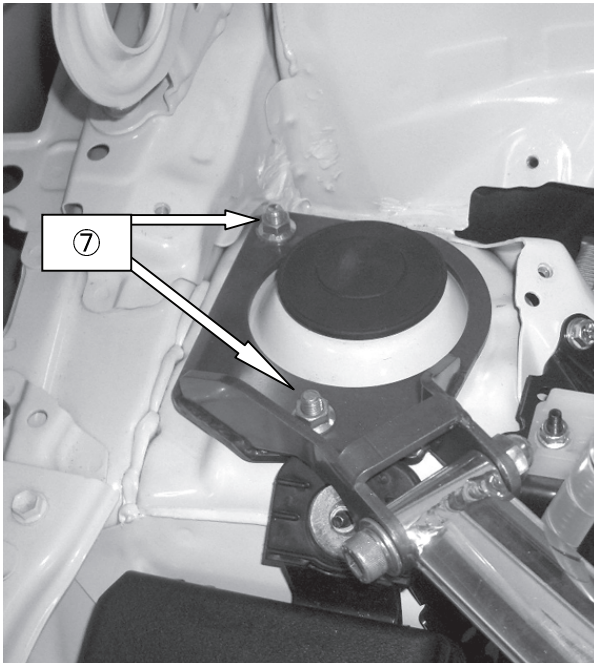
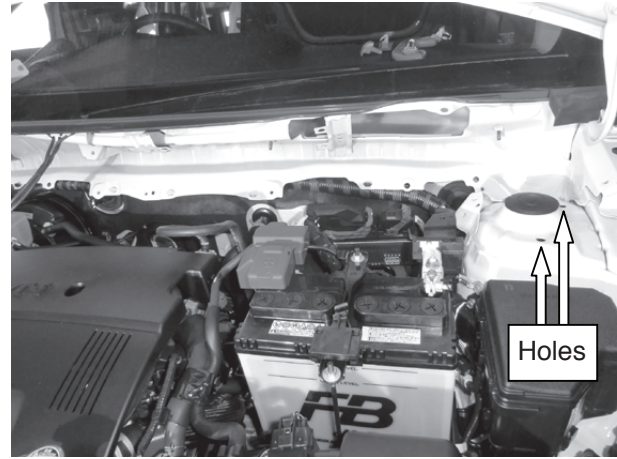
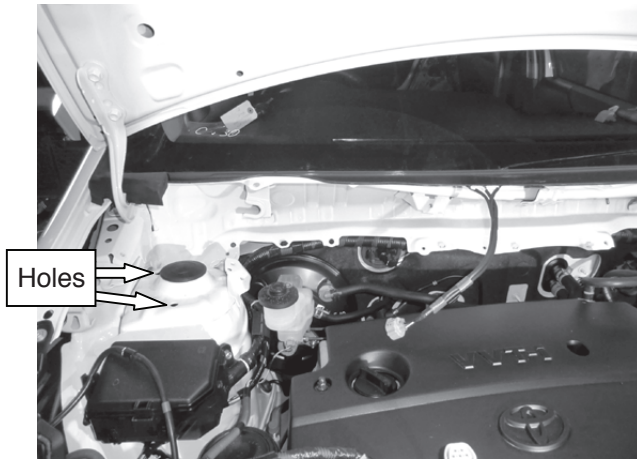

- 8.) Reinstall all components in reverse order it was taken off. Tighten all nuts and bolts according to manufacturer factory service manual torque specifications.

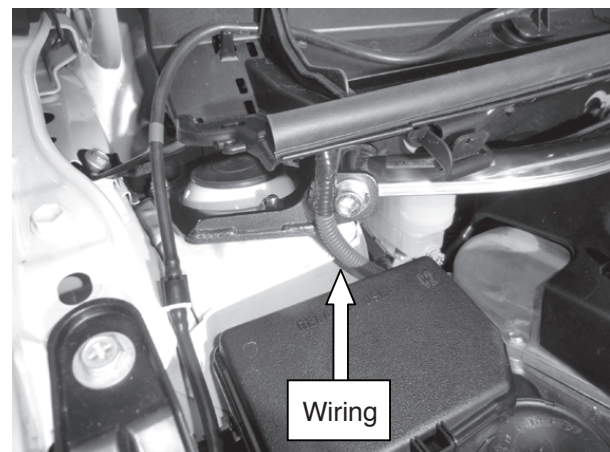
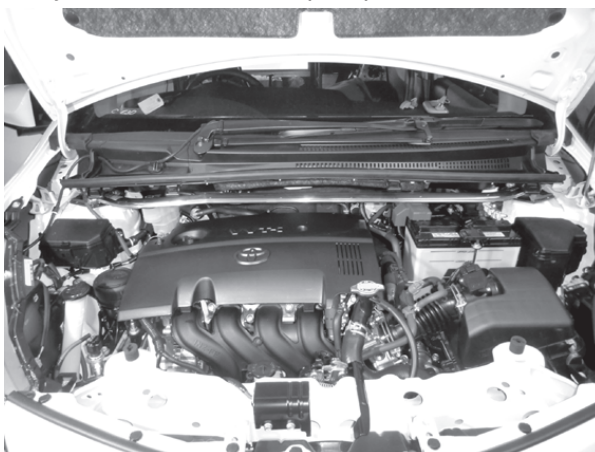

*Periodically inspect and retorque all nuts and bolts after vehicle operation.

Installation procedure for NHP10 Aqua/Prius C

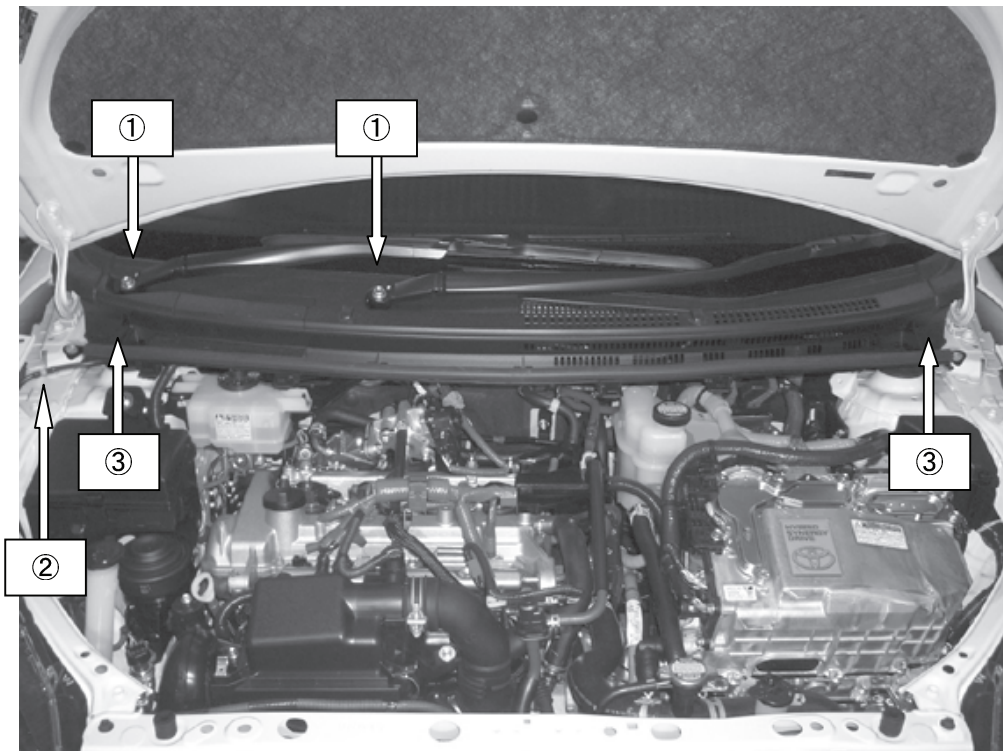

- 1.) Remove the windshield wiper arms.
- 2.) Unplug the wiper hose.
- 3.) Remove the clips located on both left and right sides.
- 4.) Remove the panels on both sides and the cowl.

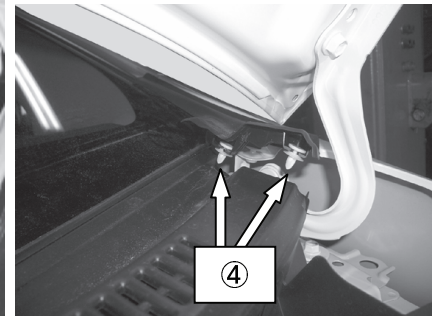

- 5.) Disconnect the wiper motor wiring connector and unclip from the cowl top panel.
- 6.) Take off the bolts to remove the entire wiper link assembly
- 7.) Take off all the bolts indicated below to remove the metal cowl top assembly.

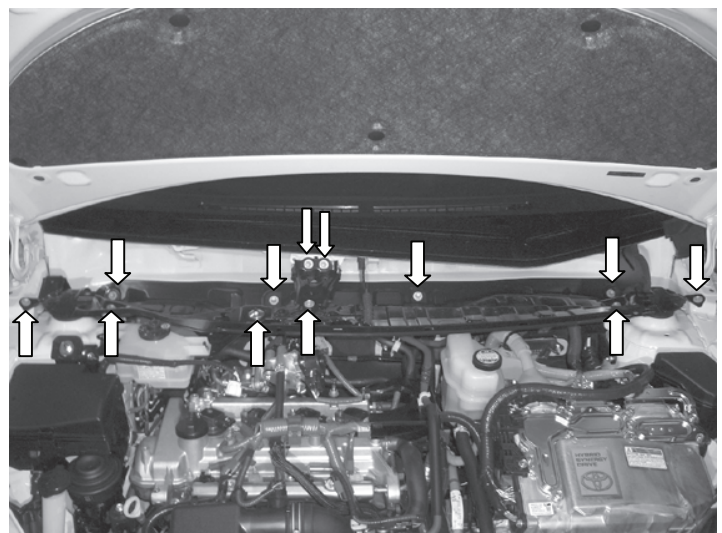
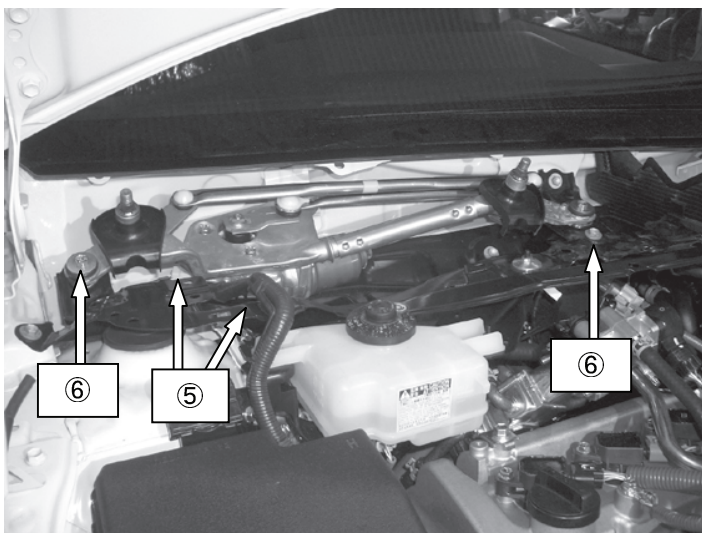

- 8.) Locate the two mounting holes on each strut tower area. Insert the included specialty bolt from under the fender wheel well while placing the strut tower bar on top. Torque down the strut tower bar using the included M8 Flanged Nuts.

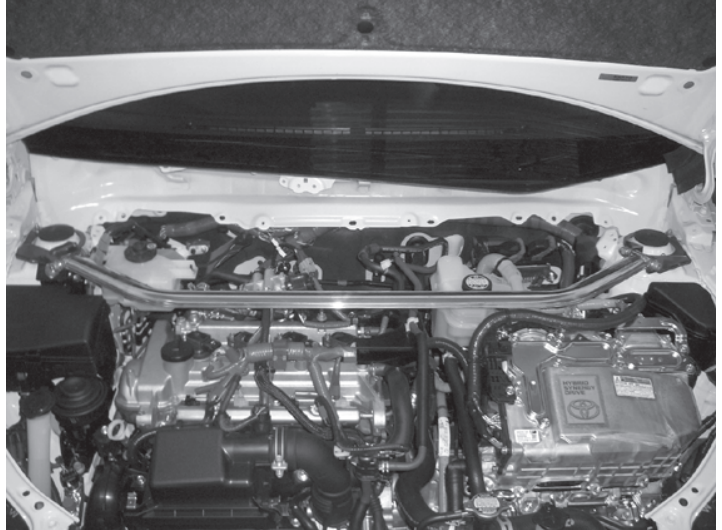
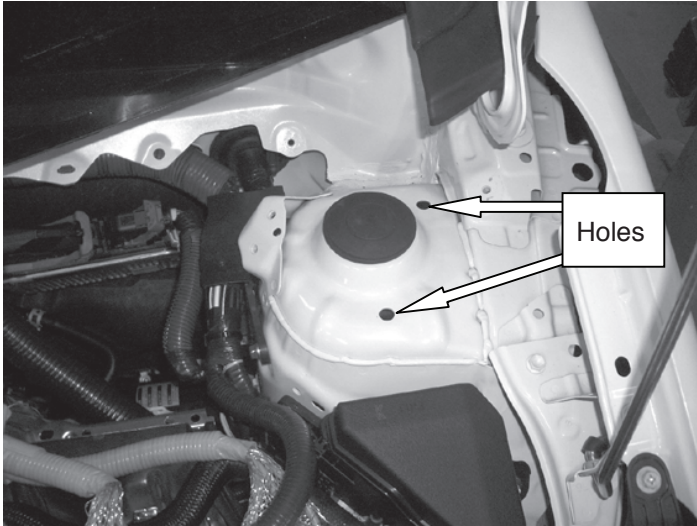

- 9.) Wrap the wiper wiring harness with the included Spiral Tube in the specified area shown below.

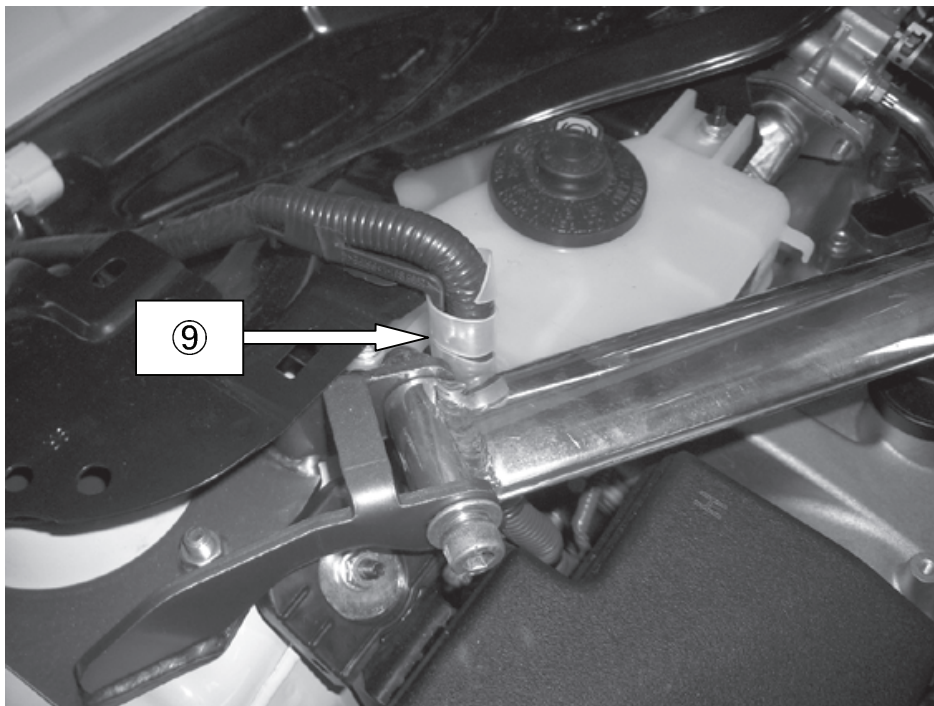

- 10.) Reinstall all components in reverse order it was taken off. Tighten all nuts and bolts according to manufacturer factory service manual torque specifications.

*Periodically inspect and retorque all nuts and bolts after vehicle operation.