



ALL PARTS LIST  
for  
**SUBARU IMPREZA STI**  
**GDB**  
**CHASSIS**



**APPLIED A~B :**  
**USDM 02 - 03**  
**BUG**  
**EYE**



**APPLIED C~D :**  
**USDM 04 - 05**  
**BLOB**  
**EYE**



**APPLIED E~G :**  
**USDM 06 - 07**  
**HAWK**  
**EYE**

**sports ZERO 3X**

**MONOTUBE SHOCKS** Pillow Upper : Front  
**24x3 WAY ADJUST** Pillow Upper : Rear

- Full height adjustable coilover structure
- 3 way dampening precise adjustment  
Rebound: 24 way, Compression: Hi- 24way + Low 24 way
- Mono-tube inverted shock layout
- External reservoir for increased capacity
- Front: pillowball camber adjustable  
Rear: pillowball upper mount

**BUG** **BLOB** **667 63X CP : \$ 4,380 msrp**  
**HAWK** **672 63X CP : \$ 4,380 msrp**



**sports ZERO 3R**

**MONOTUBE SHOCKS** Pillow Upper : Front  
**24 WAY ADJUST** Pillow Upper : Rear

- Full height adjustable coilover structure
- 24 way adjustable needle valve shocks
- Mono-tube inverted shock layout
- Front: pillowball camber adjustable  
Rear: pillowball upper mount

**BUG** **BLOB** **667 63R CP : \$ 2,680 msrp**  
**HAWK** **672 63R CP : \$ 2,680 msrp**



**sports ZERO 3S**

**MONOTUBE SHOCKS** Pillow Upper : Front  
**24 WAY ADJUST** HD Rubber Upper : Rear

- Full height adjustable coilover structure
- 24 way adjustable needle valve shock absorber
- Mono-tube inverted shock layout
- Front: pillowball camber adjustable  
Rear: HD rubber upper mount

**BUG** **BLOB** **667 63S CN : \$ 2,480 msrp**  
**HAWK** **672 63S CN : \$ 2,480 msrp**



**sports ZERO 3G**

**MONOTUBE SHOCKS** **24 WAY ADJUST**

- Full height adjustable coilover structure
- 24 way adjustable needle valve shocks
- Mono-tube inverted shock layout
- Custom-Order Based Tuning and Selections to meet the demands of specific venue, regulations, and competition requirements

[ Tarmac Rally / Gymkhana Spec ]  
**BUG** **BLOB** **667 63C SB0 : \$ 2,480 msrp**  
**HAWK** **672 63C SB0 : \$ 2,480 msrp**  
  
[ Gravel Rally / Dirt Track Spec ]  
**BUG** **BLOB** **667 63C LB0 : \$ 2,880 msrp**  
**HAWK** **672 63C LB0 : \$ 2,880 msrp**

\* Upper mount & Spring less

**street ZERO A**

- The Highest Spec in Twin-Tube models**
- Twin - Tube Design
  - Full Height Adjustment
  - 40 way Rebound Adjustments
  - Work with e-CON 2 Electric Controller (optional)
  - Front : Pillow Ball Uppermount (front strut only)

**BUG** **BLOB** **667 61N CN : \$ 1,700 msrp**  
**HAWK** **672 61N CN : \$ 1,700 msrp**

\* Rear Pillow Ball Upper Mount option  
CP1 : \$100 additional



**street ZERO**

- Basic Height Adjustable Coilover**
- Twin - Tube Design
  - Full Height Adjustment
  - Preload Adjust
  - Front : Pillow Ball Uppermount (front strut only)

**BUG** **BLOB** **667 61P CN : \$ 1,580 msrp**  
**HAWK** **672 61P CN : \$ 1,580 msrp**

\* Rear Pillow Ball Upper Mount option  
CP1 : \$100 additional

**NEW LOW PRICE**



Set the shocks from the driver seat  
**e-Con2**

**40 WAY ELECTRONIC DAMPER CONTROL e-Con2**  
**Street ZERO-A Kit**  
: 00B 60J 1214  
**\$634 (MSRP)**

- Adjust 40way of front & rear shocks dampening
- Switch between vertical & horizontal display
- Record and save up to 4 shock setting profiles
- 7 different illumination colors to choose from
- G Sensor feature \$131 (Sold separately)



**Front Sway Bar**

**BUG** **BLOB** **HAWK**  
[ 21 mm OD Spec. ]  
part no. : 667 311 A21  
price : \$240 MSRP  
\* OD = 21 MM : 136 % vs. Stock

**BUG** **BLOB** **HAWK**  
[ 22 mm OD Spec. ]  
part no. : 667 311 A21  
price : \$240 MSRP  
\* OD = 22 MM : 175 % vs. Stock

**Rear Sway Bar**

**BUG** **BLOB**  
part no. : 666 311 BJ22  
price : \$240 MSRP  
\* OD = 22 mm  
3 Level Adjustable :  
135% / 148% / 185% vs. Stock

**HAWK**  
part no. : 669 311 BJ22  
price : \$240 MSRP  
\* OD = 22 mm  
3 Level Adjustable :  
135% / 148% / 185% vs. Stock



**HD Front Swaybar End Link**

part no. : 667 318 A  
price : \$74 MSRP

**BUG** **BLOB** **HAWK**



**Rear Suspension Rod**

[ Lateral GT Link : Front side ]

**BUG** **BLOB**  
part no. : 666 484 LA  
price : \$254 MSRP  
\* Hybrid pillow ball type

**HAWK**  
part no. : 672 484 LA  
price : \$254 MSRP  
\* Hybrid pillow ball type

[ Pillow Ball Lateral Link : Front side ]

**BUG** **BLOB** **HAWK**  
part no. : 666 474 LA  
price : \$254 MSRP  
\* Pillow Ball / Adjustable Length : + 15 mm ~ - 5 mm

[ Lateral GT Link : Rear side ]

**BUG**  
part no. : 666 484 LC  
price : \$347 MSRP  
\* Hybrid pillow ball type / Pillow Ball Sway bar Link

**BLOB**  
part no. : 669 484 LC  
price : \$347 MSRP  
\* Hybrid pillow ball type / Pillow Ball Sway bar Link

**HAWK**  
part no. : 672 484 LC  
price : \$347 MSRP  
\* Hybrid pillow ball type / Pillow Ball Sway bar Link  
\* Not with HID model

[ HD Rubber Lateral Link : Rear side ]

**BUG**  
part no. : 666 474 LC  
price : \$307 MSRP  
\* HD Rubber Bushing Type / Pillow Ball Sway bar Link

[ Trailing Rod ]

**BUG** **BLOB** **HAWK**  
part no. : 666 474 T  
price : \$560 MSRP  
\* Pillow Ball / Adjustable Length : + 10 mm ~ - 10 mm



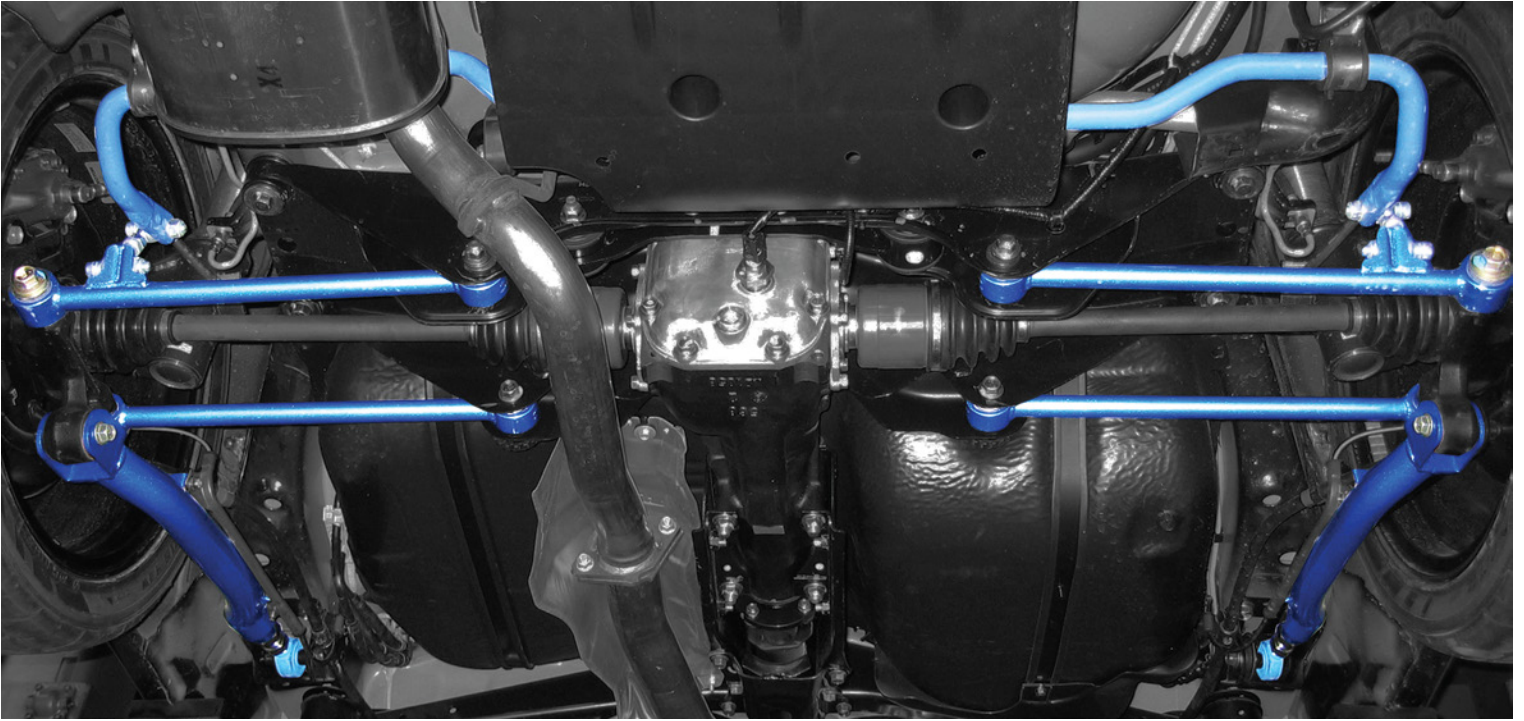

[ Pillow Ball Lateral Link : Rear side ]

**BUG**

part no. : 666 474 LB

price : \$734 MSRP

\* Pillow Ball / Adjustable Length : + 15 mm ~ - 5 mm

**BLOB**

part no. : 669 474 LB

price : \$734 MSRP

\* Pillow Ball / Adjustable Length : + 15 mm ~ - 5 mm

**HAWK**

part no. : 672 474 LB

price : \$734 MSRP

\* Pillow Ball / Adjustable Length : + 15 mm ~ - 5 mm

\* Not with HID model



**Pillowball Upper Mount**

[ Camber Adjustable : Front ]

**BUG BLOB HAWK**  
 part no. : 666 410 A  
 price : \$320 MSRP  
 \* Pillow Nut : H4 / Pillow Collar : 01  
 \* Ride height will increase 10 mm

[ Camber Adjustable HD Gravel Spec : Front ]

**BUG BLOB HAWK**  
 part no. : 666 440 CA  
 price : \$360 MSRP  
 \* HD 8 mm thick mounting plate (Black)  
 \* Pillow Nut : H4 / Pillow Collar : 01  
 \* Ride height will increase 10 mm

[ Gravel Rally Spec. 18mm: Front ]

**BUG BLOB HAWK**  
 part no. : 666 445 A  
 price : \$467 MSRP  
 \* Pillow Nut : H4 / Pillow Collar : 01  
 \* HD 18 mm pillow ball

[ Gravel Rally Spec. 22 mm : Front ]

**BUG BLOB HAWK**  
 part no. : 666 445 A22  
 price : \$894 MSRP  
 \* Pillow Nut & Pillow Collar sold separately  
 \* HD 22 mm pillow ball Special

[ Camber Adjustable : Rear ]

**BUG BLOB HAWK**  
 part no. : 658 420 A  
 price : \$320 MSRP  
 \* Pillow Nut : I / Pillow Collar : 01  
 \* Straight shape spring only

**Camber Adjust**



Enables camber adjustment on suspension coilovers. Correct wheel alignment irregularities or setup the suspension to your specific race setting.

- Quick steering feedback and rigid feel
- 6mm thick Duralumin 2017S plates (8mm on some vehicles)
- Pillow nut & collar caters to various suspension systems

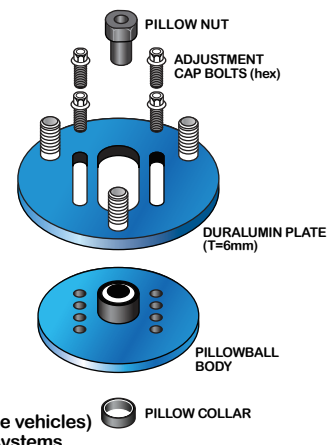

**Fixed Pillowball Upper Mount**



- Can be mounted directly on top of spring via inner sheet
  - Quick steering feedback and rigid feel
  - 10mm thick Duralumin 2017S plates
  - Pillow nut & collar caters to various suspension systems
- Special rally Gravel Spec avail with larger pillowball (MBWT18 & MBTW22)

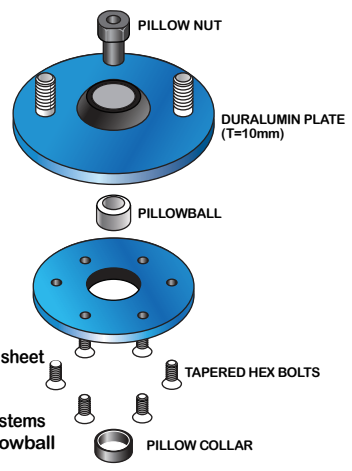

**Shift Linkage Bushing**

**BUG BLOB HAWK**  
 part no. : 692 940 A  
 price : \$40.00 MSRP  
 \* 6 sp MT only



**Subaru Pillow Ball Bushings**

<b>BUG BLOB HAWK</b>	1 : Front Lower Arm - Front	part no. : 667 464 BV price : \$240 MSRP	7 : Lateral Link Front - Out Side	part no. : 660 464 LV price : \$307 MSRP
	2 : Front Lower Arm - Rear	part no. : 660 464 CV price : \$360 MSRP	8 : Trailing Arm	part no. : 660 464 EV price : \$227 MSRP
	3 : Trailing Arm	part no. : 660 464 EV price : \$227 MSRP	9 : Knuckle Bushing	part no. : 660 464 NV price : \$227 MSRP
	4 : Lateral Link Rear - Out Side	part no. : 660 464 LV price : \$307 MSRP		
	5 : Lateral Link Rear - Body Side	part no. : 660 464 LV price : \$307 MSRP		
	6 : Lateral Link Front - Body Side	part no. : 660 464 JV price : \$307 MSRP		



# CUSCO LSD

## Limited Slip Differentials

**BUG** **BLOB** **HAWK**

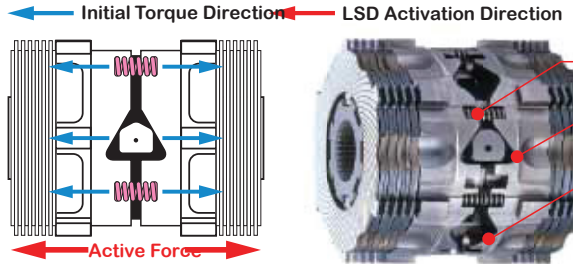

**RS Spring**  
In the RS Model, the activation pressure is applied to the same direction of the initial torque with the utilization of coil springs. Therefore, it enables a smoother and quicker initial clutch plates engagement from a non operational to a fully functioning state, even with a low initial torque setting. The virtues of a low initial torque setting is that it enables a smooth turn even while the LSD mechanism is not activated. Because of the coil spring design, it provides overall gentle and stable operation.

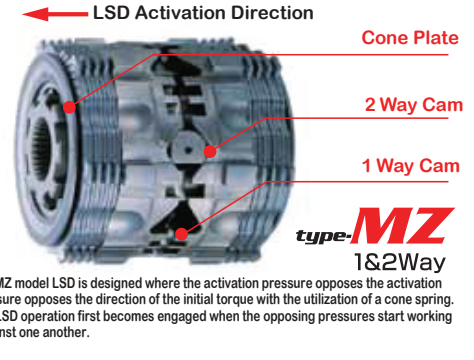
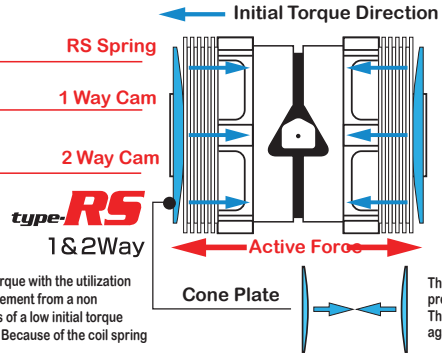

The MZ model LSD is designed where the activation pressure opposes the activation pressure of the initial torque with the utilization of a cone spring. The LSD operation first becomes engaged when the opposing pressures start working against one another.

**[ RS type : Front ]**

1 way <35 degree & 45 degree>

part no. : LSD 184 F  
price : \$1,400 MSRP

1 way & 1.5 way

part no. : LSD 184 C for 1 way  
part no. : LSD 184 C15 for 1.5 way  
price : \$1,400 MSRP

**[ MZ type : Front ]**

1 way <35 degree & 45 degree>

part no. : LSD 184 A  
price : \$1,400 MSRP

1 way & 1.5 way

part no. : LSD 184 B for 1 way  
part no. : LSD 184 B15 for 1.5 way  
price : \$1,400 MSRP

**[ Pro Adjust type : Front ]**

part no. : LSD 184 R

price : \$1,880 MSRP  
\* 0, 15, 25, 35, 45, 55, & 65 degree  
\* 0 & 15 degree can not set for acceleration side.  
\* Extra cam chip set : \$200 MSRP (initial cam set is included)

**[ RS type : Rear ]**

1 way & 2 way

part no. : LSD 182 F for 1 way  
part no. : LSD 182 F2 for 2 way  
price : \$1,400 MSRP

1.5 way & 2 way

part no. : LSD 182 L15 for 1.5 way  
part no. : LSD 182 L2 for 2 way  
price : \$1,400 MSRP

**[ MZ type : Rear ]**

1 way & 2 way

part no. : LSD 182 A for 1 way  
part no. : LSD 182 A2 for 2 way  
price : \$1,347 MSRP

1.5 way & 2 way

part no. : LSD 182 K15 for 1.5 way  
part no. : LSD 182 K2 for 2 way  
price : \$1,347 MSRP

**[ Pro Adjust type : Rear ]**

part no. : LSD 182 R

price : \$1,880 MSRP  
\* 0, 15, 25, 35, 45, 55, & 65 degree  
\* 0 & 15 degree can not set for acceleration side.  
\* Extra cam chip set : \$200 MSRP (initial cam set is included)

**1 way <Gymkhana / High initial spec>**

part no. : LSD 182 FG for 1 way  
\* 55 degree 1 way cam only  
\* 24 pcs RS spring capacity  
price : \$1,400 MSRP

**[Center diff : RS Type ]**

\* Viscus Center diff.  
2 way  
part no. : LSD 187 F  
price : \$1,507 MSRP



**Subaru Impreza Wrx Sti (R180 Rear End) Increased Capacity Differential Cover**

**BUG** **BLOB** **HAWK**

part No: (Blue) 692 008 AL  
part No: (Silver) 692 008 AS

price : \$907.00 MSRP



**Reinforced Differential Carrier**

**BUG BLOB HAWK**

part no. : 6A1 489 A  
price : \$174 MSRP  
\* Pre-installed heavy-duty rubber bushings



**Intercooler Protection Net**

**BUG BLOB HAWK**

part no. : 6A1 035 A  
price : \$178 MSRP  
\* Quick-release lever system

**Clutch / Flywheel**

**BUG BLOB HAWK**

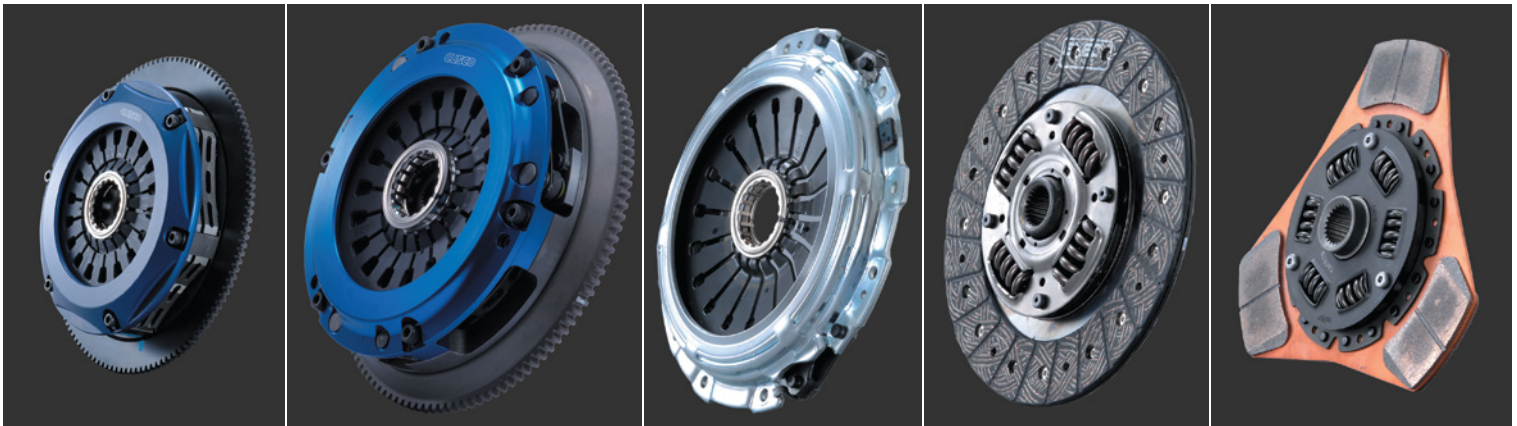

**[ Twin Metal Clutch System ]**

part no. : 667 022 TP  
price : \$2,526 MSRP

**[ Copper Single Disc ]**

part no. : 00C 022 R667  
price : \$386 MSRP

**[ Copper Single Set ]**

part no. : 667 022 F  
price : \$798 MSRP  
\* Copper Disc & Clutch Cover

**[ Twin Copper Clutch System ]**

part no. : 667 022 CP  
price : \$2,640 MSRP

**[ Thick Metal Disc ]**

part no. : 00C 022 C667F  
price : \$415 MSRP

**[ Thick Metal Disc ]**

part no. : 667 022 G  
price : \$798 MSRP  
\* Copper Disc & Clutch Cover

**[ Single Clutch System ]**

part no. : 667 022 HP  
price : \$1,799 MSRP

**[ Cusco Clutch Cover ]**

part no. : 00C 022 B667  
price : \$500 MSRP

**[ Light Weight Flywheel ]**

part no. : 667 023 A  
price : \$734 MSRP

**Braided Stainless Steel Clutch Cable**

**BUG BLOB HAWK**

6 SPD ONLY  
part no. : 672 022 CL  
price : \$120 MSRP



**Strut Tower Brace**

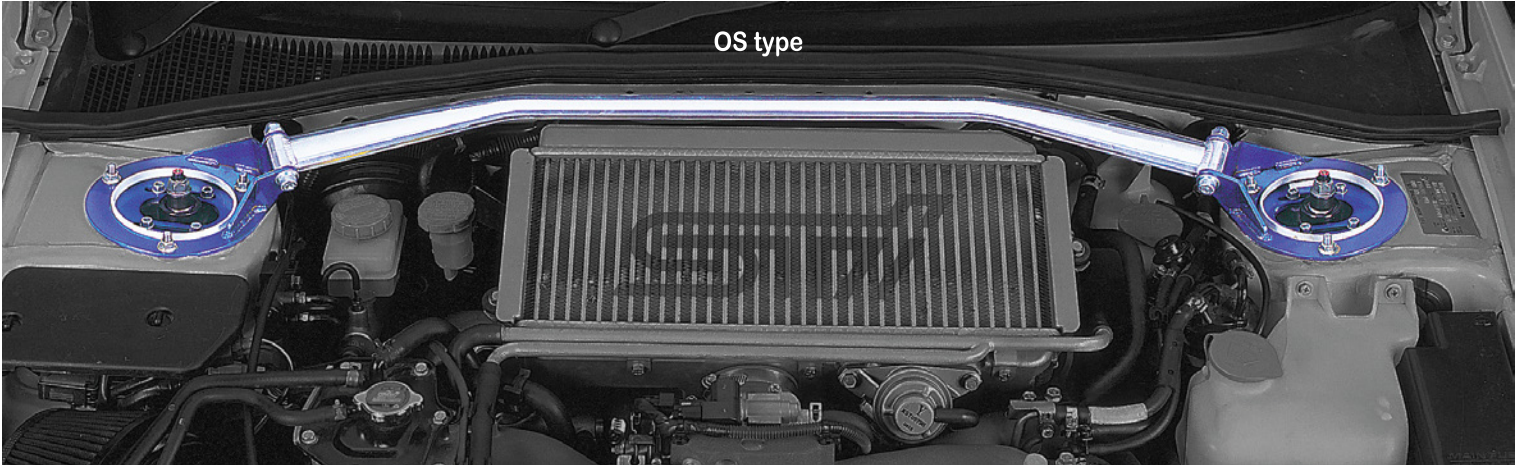

OS type



OS type

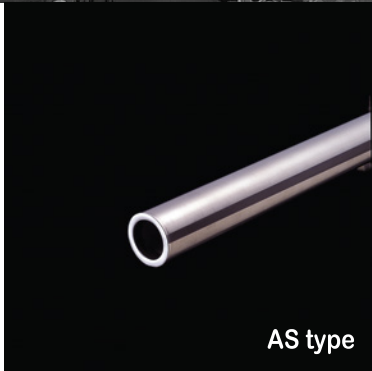

AS type



40 type



CB type

[ Front Strut Bar : OS type ]

part no. : 667 540 ALHD  
price : \$200 MSRP

\* **HAWK** need to relocate A/C hose

[ Rear Strut Bar : OS-T ]

part no. : 660 544 A  
price : \$160 MSRP

\* Add on triangle bar to rear strut bar.



[ Brake Cylinder Stopper ]

part no. : 666 561 ALHD  
price : \$114 MSRP



[ Rear Strut Bar : OS type ]

part no. : 666 541 A  
price : \$200 MSRP

[ Rear Strut Bar : 40 type ]

part no. : 666 526 A  
price : \$240 MSRP

[ Rear Strut Bar : AS type ]

part no. : 666 511 A  
price : \$160 MSRP

[ Rear Strut Bar : CB type ]

part no. : 666 551 A  
price : \$294 MSRP

**Quick Release Lever**



[ 2 pcs per set ]

part no. : 00B 540 C  
price : \$54 MSRP

\* 2 pcs per set  
\* OS type strut bar only



**Lower Arm Bar**



[ Ver. 1 : 2 point brace ]

part no. : 666 475 A  
price : \$100 MSRP

\* Not work with Ver. 2

[ Ver. 2 : 4 point brace ]

part no. : 666 477 A  
price : \$200 MSRP

\* Not work with Ver. 1

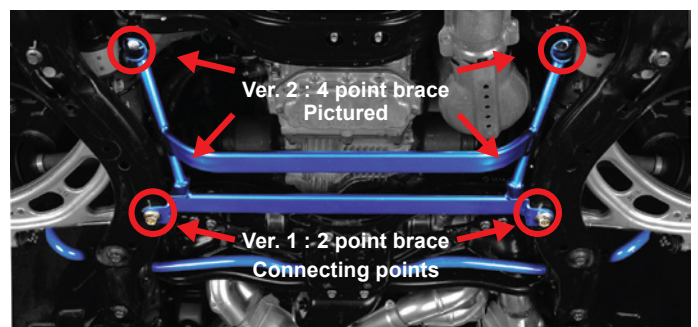



**Rear Subframe Brace**

**BUG** **BLOB** **HAWK**

part no. : 673 487 A  
price : \$160 MSRP

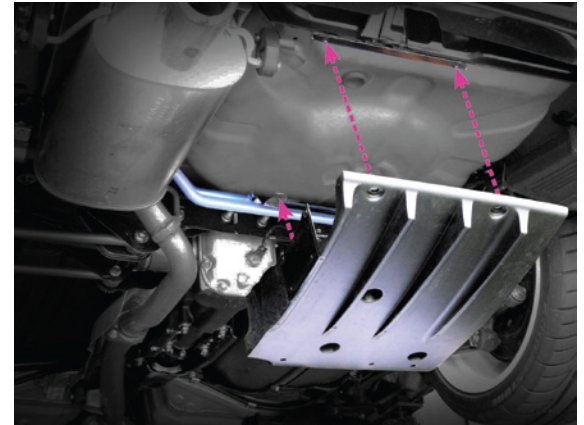
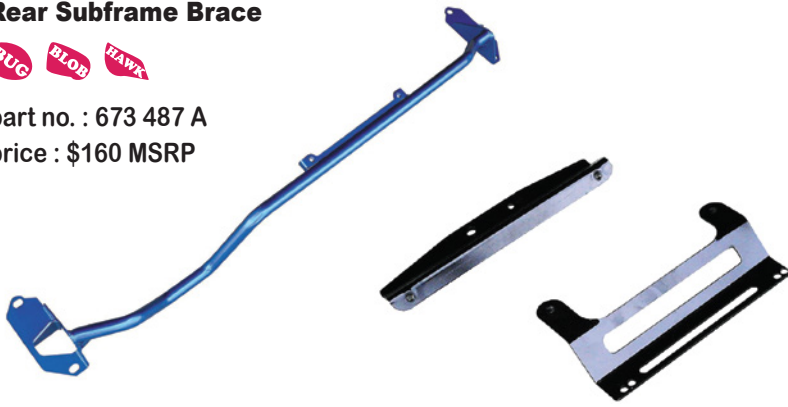

[ Subaru OE Rear Diffuser bracket ]

**BUG** **BLOB** **HAWK**

part no. : 672 487 S  
price : \$51 MSRP

\* 06 diffuser can be mounted on 05 & older.

[ Subaru OE Rear Diffuser ]

**BUG** **BLOB**

part no. : ST91225 FE000  
price : \$72 MSRP

\* Subaru OE parts

[ Rear Diffuser Mounting Bolts ]

**BUG** **BLOB**

part no. : ST90100 0365  
price : \$1.80 MSRP / each

\* Subaru OE parts : need 4 pcs

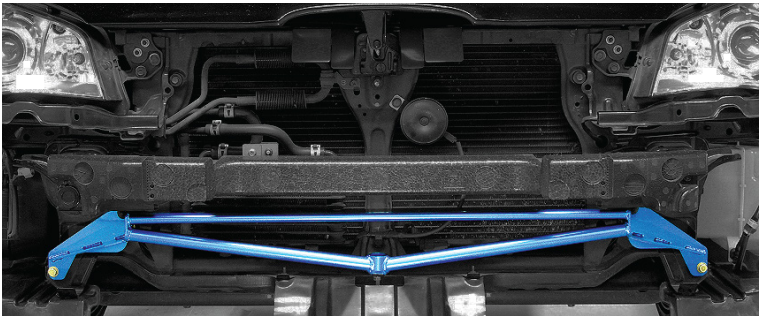

**Front Member Power Brace**

**BLOB** **HAWK**

part no. : 672 492 FMLHD  
price : \$254 MSRP  
\* Remove factory bumper beam



**Floor Rear Power Brace**

**BUG** **BLOB** **HAWK**

part no. : 672 492 R  
price : \$167 MSRP

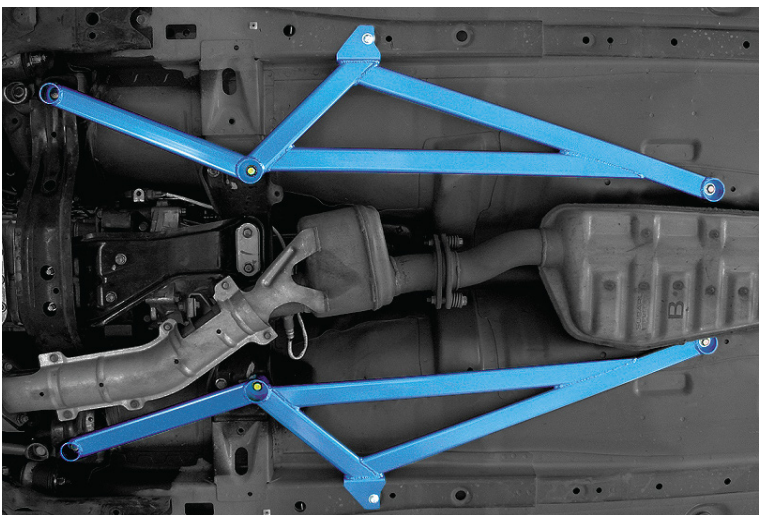

**Floor Center Power Brace**

**BUG** **BLOB** **HAWK**

part no. : 672 492 C  
price : \$507 MSRP



**Rear Trunk Power Brace**

**BUG** **BLOB** **HAWK**

part no. : 672 492 RT  
price : \$227 MSRP

**ROLLCAGE**



**CUSCO D1 SPEC ROLLCAGE 40MM OD CHRO-MOLY**

WEIGHT 10.5kg	WEIGHT 12.8kg	WEIGHT 18.6kg	WEIGHT 20.9kg	WEIGHT 23.2kg
4 POINT	5 POINT	6 POINT	7 POINT	8 POINT



**CUSCO SAFETY21 ROLLCAGE 40MM OD STEEL CONSTRUCTION**

WEIGHT 13.0kg	WEIGHT 16.0kg	WEIGHT 24.0kg	WEIGHT 27.0kg	WEIGHT 30.0kg
4 POINT	5 POINT	6 POINT	7 POINT	8 POINT
9 POINT	10 POINT	11 POINT	12 POINT	13 POINT
				15 POINT

**DASH THROUGH**



**DASH ESCAPE**

FIA APPROVED ROLL CAGES ALSO AVAIL. PLEASE INQUIRE

SUBARU IMPREZA			BUG BLOB HAWK			
ROLLCAGE			STEEL/SAFETY21		CHRO-MOLY/D1	
POINT	PASSENGER	FRONT TYPE	ITEM	MSRP	ITEM	MSRP
4 PT	2	N/A	666 270 C20	\$ 534.00	666 261 C	\$ 600.00
	5	N/A	666 270 A20	\$ 534.00	666 261 A	\$ 600.00
5 PT	2	N/A	666 270 D20	\$ 667.00	666 261 D	\$ 774.00
	5	N/A	666 270 K20	\$ 667.00	666 261 K	\$ 774.00
6 PT	2	ESCAPE	666 270 E20	\$ 867.00	666 261 E	\$ 960.00
	2	THROUGH	666 290 E20	\$ 867.00	666 265 E	\$ 960.00
	5	ESCAPE	666 270 B20	\$ 867.00	666 261 B	\$ 960.00
	5	THROUGH	666 290 B20	\$ 867.00	666 265 B	\$ 960.00
7 PT	2	ESCAPE	666 270 F20	\$ 1,000.00	666 261 F	\$ 1,134.00
	2	THROUGH	666 290 F20	\$ 1,000.00	666 265 F	\$ 1,134.00
	5	ESCAPE	666 270 L20	\$ 1,000.00	666 261 L	\$ 1,134.00
	5	THROUGH	666 290 L20	\$ 1,000.00	666 265 L	\$ 1,134.00
8 PT	2	ESCAPE	666 270 G20	\$ 1,134.00	666 261 G	\$ 1,334.00
	2	THROUGH	666 290 G20	\$ 1,134.00	666 265 G	\$ 1,334.00
9 PT	2	ESCAPE	666 270 W9	\$ 1,160.00		
	2	THROUGH	666 290 W9	\$ 1,160.00		
10 PT	2	ESCAPE	666 270 W10	\$ 1,294.00		
	2	THROUGH	666 290 W10	\$ 1,294.00		
12 PT	2	ESCAPE	666 270 W12	\$ 1,560.00		
	2	THROUGH	666 290 W12	\$ 1,560.00		
13 PT	2	ESCAPE	666 270 W13	\$ 1,694.00		
	2	THROUGH	666 290 W13	\$ 1,694.00		



**ASN / FIA Roll Cage**



part no. : 672 290 W07  
price : \$2,774 MSRP  
\* 2 Passenger / Dash Through

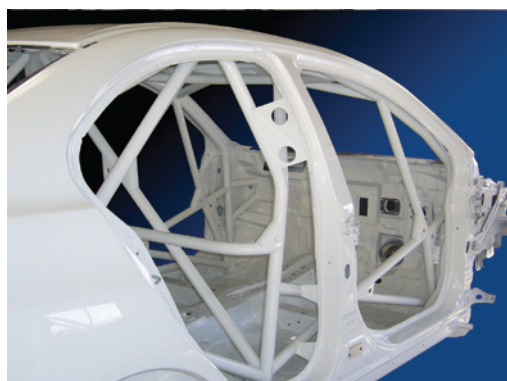
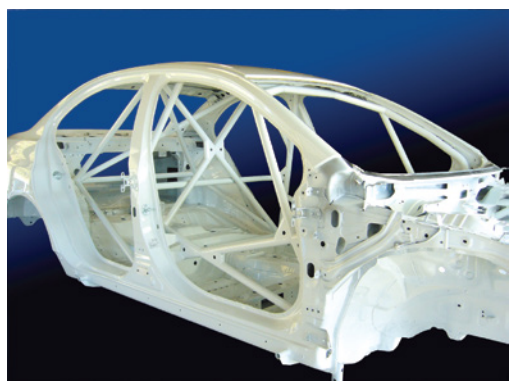

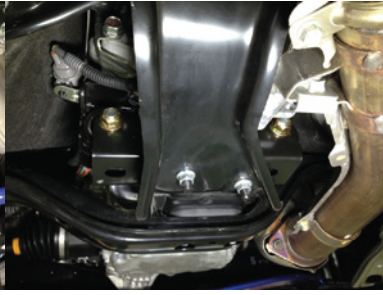

**HD Motor & Transmission Mount Set**

**BUG** **BLOB** **HAWK**  
 part no. : 660 911 SET  
 price : \$347 MSRP

**HD Exhaust Muffler Ring**

**BUG** **BLOB** **HAWK**  
 part no. : A160 RM 002B  
 price : \$12 MSRP / each

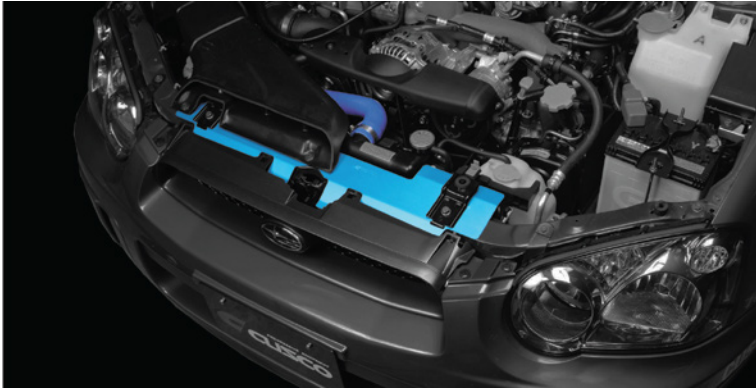

**Radiator Cooling Plate**

**BUG** **BLOB**  
 part no. : 667 003 AL  
 price : \$131 MSRP

**Radiator Cooling Plate**

**HAWK**  
 part no. : 673 003 AL  
 price : \$131 MSRP



**Air Intake Silicon Hose**

**BUG** **BLOB** **HAWK**  
 part no. : 667 037 A  
 price : \$54 MSRP

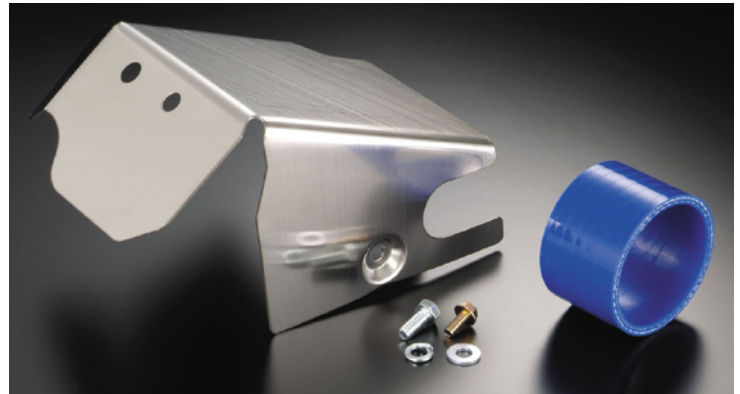

**Turbo Heat Shield**

**BUG** **BLOB** **HAWK**  
 part no. : 667 045 A  
 price : \$91 MSRP

**Turbo Heat Shield & Air Intake Silicon Hose Set**

**BUG** **BLOB** **HAWK**  
 part no. : 667 045 B  
 price : \$131 MSRP

**Aluminum Pulley Set**

**BUG** **BLOB** **HAWK**  
 part no. : 6A1 733 A  
 price : \$307 MSRP  
 \* Alternator, Crank, &  
 Water Pump





**Street Oil Catch Tank**

**BUG** **BLOB**  
part no. : 672 009 AN  
price : \$131 MSRP  
\* 0.3 L Capacity

**Street Oil Catch Tank**

**HAWK**  
part no. : 673 009 A  
price : \$131 MSRP  
\* 0.3 L Capacity



**COMPETITION OIL CATCH**

**Race Oil Catch Tank : Universal**

**[ Side Mount ]**  
part no. : 00B 009 JB  
price : \$131 MSRP  
\* 0.6 L Capacity

**[ Race : 3L ]**  
part no. : 00A 011 A  
price : \$200 MSRP  
\* 3L Capacity



**SEPARATOR OIL CATCH**

**[ Separator Type : 2L ]**

part no. : 00B 010 A  
price : \$240 MSRP

**[ Separator Type : 0.35L ]**

part no. : 00B 011 A  
price : \$240 MSRP



**High Pressure Radiator Cap : A-type**

**BUG** **BLOB** **HAWK**  
part no. : 00B 050 A13  
price : \$34 MSRP



**Neodymium Magnet Drain Bolt : M20 x P1.5**

**BUG** **BLOB** **HAWK**  
part no. : 00B 001 ND04  
price : \$24 MSRP



**Folding Type Tow Hook : Front**

**HAWK**  
part no. : 672 017 F  
price : \$131 MSRP



**Cusco Towing Strap**

: BLUE-00B CTS BL - \$47 MSRP  
: RED -00B CTS RD - \$47 MSRP

\* Due to universal type products, it may need modification on vehicle to install.



**Shift Knob - Black Duracon**

**BUG** **BLOB** **HAWK**  
part no. : 692 760 BA  
price : \$51 MSRP

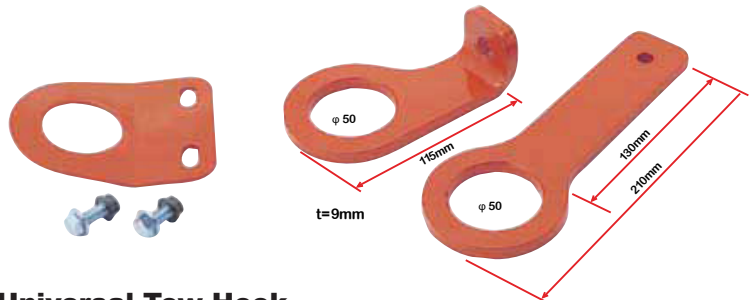

**Universal Tow Hook**

: Guard Type  
Part No. 00A 016 AD  
\$34 MSRP

: Solid Type  
Part No. 00A 016 AJ  
\$107 MSRP



**Hood Pins \*Universal :**  
 Blue - 00B 817 AL - \$54 MSRP  
 Silver - 00B 817 A - \$51 MSRP  
 Black - 00B 817 AB - \$54 MSRP  
 Lock Pins - A517 C402 - \$80 MSRP  
 Spring Trunk Hook -  
 00B 818 A - \$34 MSRP



**E-Brake Knob**  
**BUG BLOB HAWK**  
 [Blue ]  
 part no. : 692 014 AL  
 price : \$27 MSRP  
 [Silver ]  
 part no. : 692 014 AA  
 price : \$27 MSRP  
 [Red ]  
 part no. : 692 014 AR  
 price : \$27 MSRP

**Dog Transmission Gear Set**

Dog gear transmission used by the CUSCO Rally team.  
 Enhances gear engagement and eliminates power loss.



\*Retains Transmission casing but replaces OEM gears  
 \*\* Type-A uses OEM final gear  
 \*\*\*Type-B complies to FIA (uses VO gear ratio)  
 \*\*\*Please check FIA regulations for VO & VP



FIA Homologation Compliance

MODEL	TYPE	PART NUMBER	MSRP (USD)	
<b>BUG BLOB HAWK</b>	Standard	667 028 A	\$ 8,000	N-5621, N-5650, N-5656, N-5676, N-5695, N-5714
	Step 1	667 028 A1	\$ 8,800	
	Step 2	667 028 A2	\$ 9,734	



**Under Guard Kit**

**BUG BLOB HAWK**  
 [ Standard Type ]  
 part no. : 666 211 WS  
 price : \$1,467 MSRP  
 [ Heavy Duty Type ]  
 part no. : 666 211 WH  
 price : \$2,134 MSRP  
 [ Subframe Guard ]  
 part no. : 666 211 WM  
 price : \$147 MSRP



**WRC UNDERGUARD**  
 Standard Type=5mm thickness  
 Heavy Duty Type=5mm+5mm Ribbed  
 Both made from 17S Duralumin

# CUSCO×BRIDE COLLABORATION SEAT



*LOW MAX*

## ZETA III PLUS

- HANS Device Compatibility
- FIA Approved
- Black with Cusco Logo
- Carbon Aramid : 6.9 kg / 15 lbs
- FRP : 7.6 kg / 17 lbs



FRP Silver Shell **FIA APPROVED**  
Part No: BRD-H31HCF : \$1,080 (MSRP)

Carbon Aramid Shell  
Part No: BRD-H31HCR : \$2,150 (MSRP)

**FO type Seat Rail : \$240 (MSRP)**

**FG type Seat Rail : \$240 (MSRP)**



## ZETA III : Sprot - C

FRP Black Shell  
Part No: BRD-F31SCF : \$900 (MSRP)

**ZETA III** **FIA APPROVED** \*excludes Carbon Aramid Shell

FRP Silver Shell  
Part No: BRD-F31HCF : \$1,000 (MSRP)

Super Aramid Shell  
Part No: BRD-F31HCZ : \$1,400 (MSRP)

Carbon Aramid Shell  
Part No: BRD-F31HCR : \$2,000 (MSRP)

**ZETA III : Typer - L** **FIA APPROVED** \*excludes Carbon Aramid Shell

FRP Silver Shell  
Part No: BRD-FL1HCF : \$1,150 (MSRP)

Super Aramid Shell  
Part No: BRD-FL1HCZ : \$1,500 (MSRP)

Carbon Aramid Shell  
Part No: BRD-FL1HCR : \$2,200 (MSRP)

**ZETA III : Typer - X** **FIA APPROVED** \*excludes Carbon Aramid Shell

FRP Silver Shell  
Part No: BRD-F91HCF : \$1,150 (MSRP)

Super Aramid Shell  
Part No: BRD-F91HCZ : \$1,500 (MSRP)

Carbon Aramid Shell  
Part No: BRD-F91HCR : \$2,200 (MSRP)

**FO type Seat Rail : \$240 (MSRP)**

**FG type Seat Rail : \$240 (MSRP)**

**XL type Seat Rail : \$295 (MSRP)**



## STRADIA II

- Steel Frame Structure
- Luxury Suede / Fire Retardant
- Low Cushion, Stitchless
- Silver FRP Construction
- Weight : 14 kg / 31 lbs

Standard Cushion  
Part No: BRD-G33SCF : \$1,800 (MSRP)

Lowered Cushion  
Part No: BRD-G23SCF : \$1,800 (MSRP)

## STRADIA II : Type - XL

Standard Cushion  
Part No: BRD-G55SCF : \$2,150 (MSRP)

## GIAS II

High Side Bolster  
Part No: BRD-G32SCF : \$1,800 (MSRP)

**RO type Seat Rail : \$210 (MSRP)**

*LOW MAX*



## DIGO III LIGHT

- Available with CRUZ (Armrest) Option
- Touring recliner
- Anatomically ergonomic seating
- Weight : 15.2 kg / 33 lbs

Part No: BRD-D45ACS : \$1,000 (MSRP)



## DIGO III LIGHT - CRUZ

Part No: BRD-D44ACS : \$1,050 (MSRP)

## CRUZ OPTIONAL ARM REST

Right Side  
Part No: BRDA-P51ANN : \$75 (MSRP)

Left Side  
Part No: BRDA-P52ANN : \$75 (MSRP)

## EUROSTER II

- Available with CRUZ (Armrest) Option
- Fireproof Material
- Weight : 16.1 kg / 35.5 lbs (one arm rest)

Part No: BRD-E32ACN : \$1,100 (MSRP)

## EUROSTER II - CRUZ

Part No: BRD-E54ACN : \$1,150 (MSRP)

## CRUZ OPTIONAL ARM REST

Right Side  
Part No: BRDA-P51ANN : \$75 (MSRP)

Left Side  
Part No: BRDA-P52ANN : \$75 (MSRP)

**MO type Seat Rail : \$240 (MSRP)**



**Light Weight Acrylic Window**

BUG BLOB HAWK

[ All Window Kit ]

part no. : 667 800 A

price : \$2,067 MSRP

\* x2 Front Door

\* x2 Rear Door

\* x1 Rear Window



[ Door : Front / Rear ]

\* Curved 4 mm thick  
price : \$334 MSRP

[ Rear Window ]

\* Curved 3 mm thick  
price : \$734 MSRP

**RACING HARNESS**

- 6-Point FHR/HANS Devices have 2-inch wide narrow design shoulder Belts. Must use with FHR/HANS Devices as set. FIA approved.
- 6-Point 3-inch wide harness for professional to advanced drivers. FIA approved.
- Billet Aluminum Light Weight and Compact Rotary Buckle



FIA APPROVED

6 Point for HANS Devices  
- 00B CRH 6HBL - Blue  
- Price : \$420.00



FIA APPROVED

6 Point - 3 " Width  
- 00B CRH 6BL - Blue  
- 00B CRH 6BK - Black  
- Price : \$420.00



FIA APPROVED

4 Point - 3 " Width  
- 00B CRH 4BL - Blue  
- 00B CRH 4BK - Black  
- Price : \$360.00



Anti-Submarine Belt - 2 " Width  
- 00B CCS 2BL - Blue  
- 00B CCS 2BK - Black  
- Price : \$70.00

