

[Installation Manual]

[CUSCO Part No.]: **672-492-FMLHD**

[Application]: 2003–2007 Subaru Impreza WRX STi

[Product]: Power Brace, Front Member

[Kit includes]: M8 x 20mm Bolt x 1
 M8 Washer (Large) x 1
 M8 Flange Nut x 1

[Estimated Installation Time]

- **For 2003-2005 Models: Approx. 2.5 Hours (Includes Front Bumper Trim Work)**
- **For 2006-2007 Models: Approx. 1.5 Hours (No Front Bumper work required)**

[Instruction] – Following instruction is basic information only. Refer to Factory Repair Manual for more details.

1. Remove Front Radiator Grill

[For 2003-2005 Models]

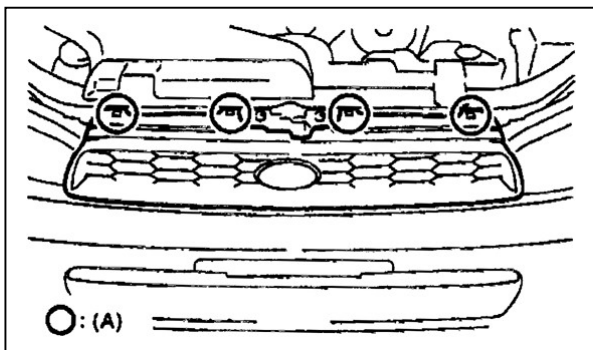

- Step 1: Disconnect (-)Battery Terminal
 Step 2: Remove all 4 clips circled (A)
 in the picture

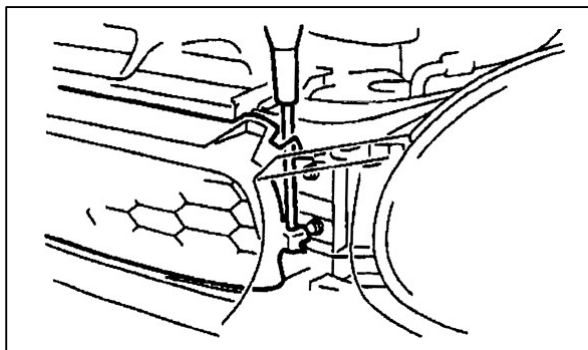

Step 3: Remove clips on bottom

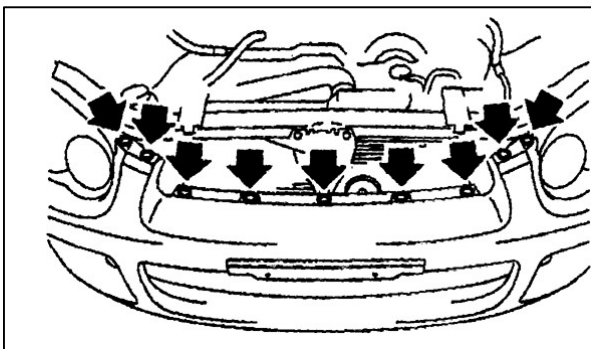

Step 4: Remove x9 clips as showing above to
 prepare the front bumper.

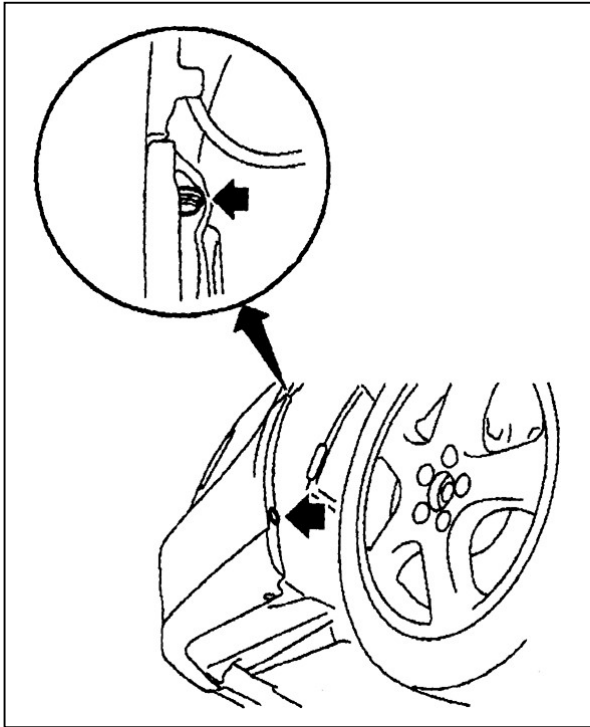

Step 5. Remove clips as showing this picture

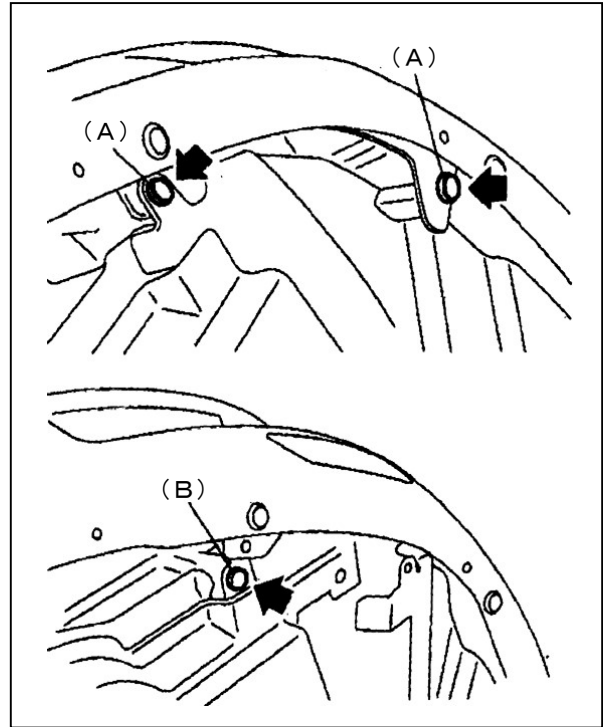

Step 6. Remove x2 (A) Clips and then remove (B) Clip on both sides under the bumper.

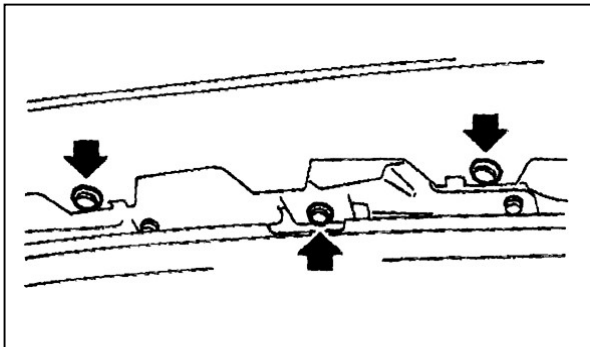

Step 7. Remove x3 Clips in center of bumper.
Step 8. Disconnect Fog Ramps harness.
Step 9. Remove front bumper.

[For 2006-2007 Models]

***Require to remove front Grill**

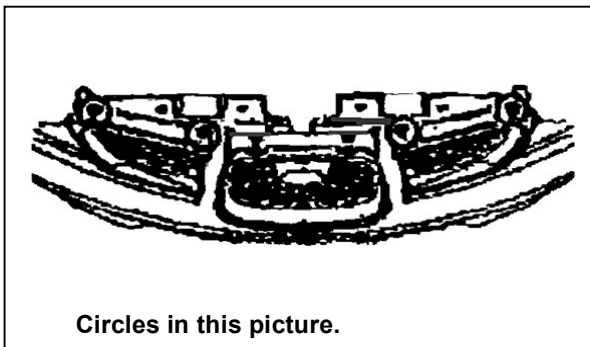

Circles in this picture.

Step 10. Disconnect (-) Battery Terminal
Step 11. Remove x4 Clips on top of grill.
Step 12. Remove both sides of grills.

- Continued from previous page-
 [Removing Front Bumper]

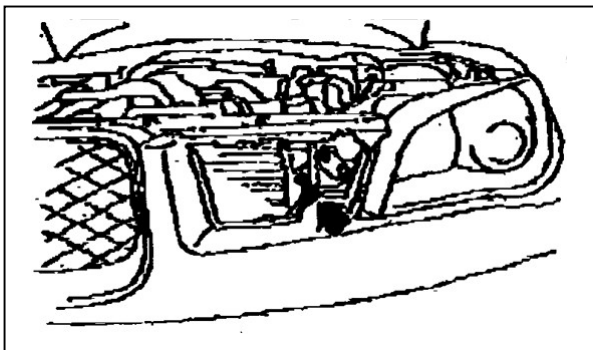

Step 13. Remove clips as showing the picture above (Arrow) on both sides.

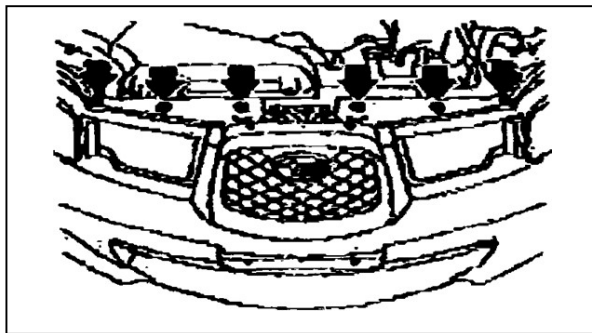

Step 14. Remove x6 Clips on top of bumper

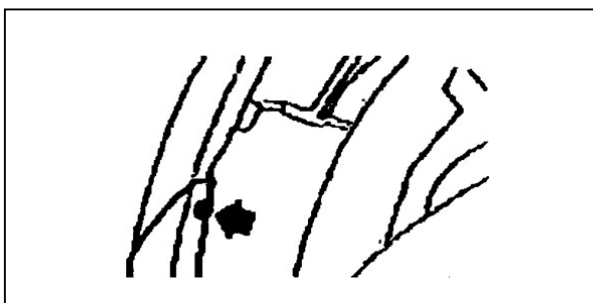

Step 14. Remove Clips to connect to the bumper on both sides

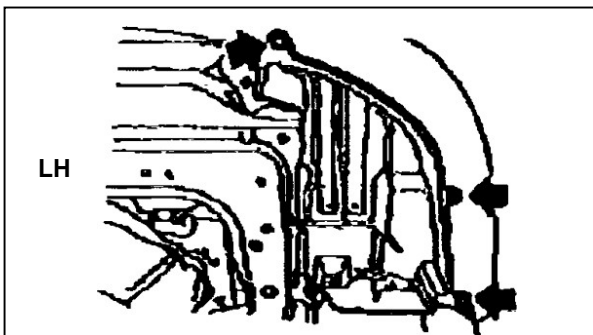

Step 15. Remove x3 Clips as showing above on both sides.

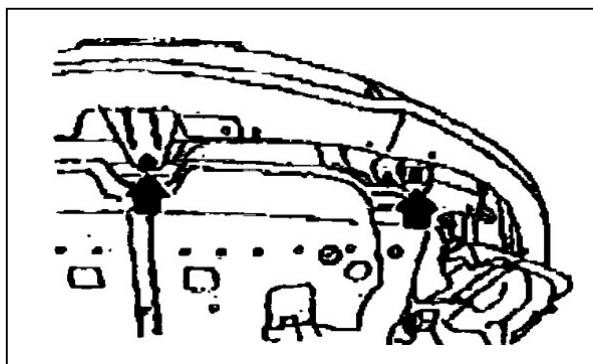
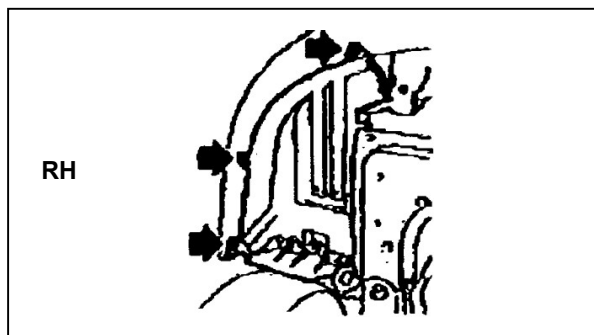

Step 16. Remove x3 (x1 Center, x1 Left and x1 Right)
 Step 17. Disconnect the harness from Fog lamps
 Step 18. Remove front bumper

Installing CUSCO Front Member Power Brace

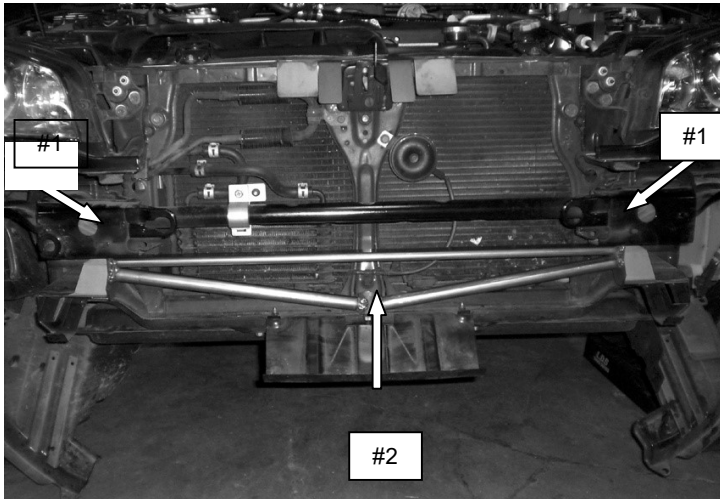

Step 19. Install CUSCO Brace with OE Bolts together (#1).

Step 20. Connect #2 by using supplied hardware (M8 L=20mm Bolt, M8 Washer, M8 Flange Nut)

Step 21. Install the front bumper – Reversed orders for removal.

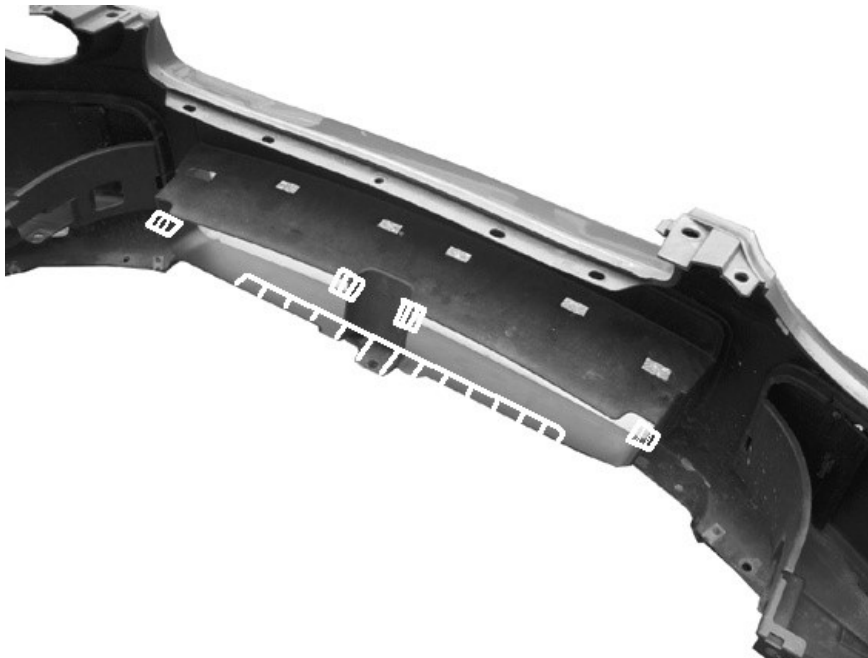

Step 22. Trim shaded area in above picture for 2003-2005 models